

Rider's Manual

F 650 GS



BMW Motorrad



The Ultimate Riding
Machine

Motorcycle data/dealership details

Motorcycle data

Model

Vehicle identification number

Colour code

Date of first registration

Registration number

Dealership details

Person to contact in Service department

Ms/Mr

Phone number

Dealership address/phone number (company stamp)

Details described or illustrated in this booklet may differ from the motorcycle's actual specification as purchased, the accessories fitted or the national-market specification. No claims will be entertained as a result of such discrepancies.

Dimensions, weights, fuel consumption and performance data are quoted to the customary tolerances.

The right to modify designs, equipment and accessories is reserved.

Errors and omissions excepted.

© 2007 BMW Motorrad

Not to be reproduced either wholly or in part without written permission from BMW Motorrad, After Sales.

Printed in Germany.

Important data for refuelling

Fuel

Recommended fuel grade	91 ROZ/RON, Regular unleaded
Usable fuel capacity	approx. 16 l
Reserve fuel	≥4 l

Tyre pressure

Tyre pressure, front	2.2 bar, one-up, at tyre temperature: 20 °C 2.2 bar, two-up and/or with luggage, at tyre temperature: 20 °C
Tyre pressure, rear	2.5 bar, one-up, at tyre temperature: 20 °C 2.9 bar, two-up and/or with luggage, at tyre temperature: 20 °C

BMW recommends 

Order No. 01 41 7 712 281
10.2007, 1st edition



Welcome to BMW

We congratulate you on your choice of a motorcycle from BMW and welcome you to the community of BMW riders.

Familiarise yourself with your new motorcycle so that you can ride it safely and confidently in all traffic situations.

Please read this Rider's Manual carefully before starting to use your new BMW motorcycle. It contains important information on how to operate the controls and how to make the best possible use of all your BMW's technical features.

In addition, it contains information on maintenance and care to help you maintain your motorcycle's reliability and safety, as well as its value.

If you have questions concerning your motorcycle, your authorised

BMW Motorrad dealer will gladly provide advice and assistance.

We hope that you will enjoy riding your BMW and that all your journeys will be pleasant and safe.

BMW Motorrad.

Table of Contents

You can also consult the index at the end of this Rider's Manual if you want to find a particular topic or item of information.

1 General instructions 5

Overview	6
Abbreviations and symbols	6
Equipment	7
Technical data	7
Currency	7

2 General views 9

General view, left side	11
General view, right side	13
Underneath the seat	14
Underneath the trim panel	15
Handlebar fitting, left	16
Handlebar fitting, right	17
Instrument cluster	18
Headlight	19

3 Status indicators 21

Standard status indicators	22
Status indicators with on-board computer ^{OE}	23
Status indicators with tyre-pressure monitoring (RDC) ^{OE}	24
Standard warnings	24
Warnings issued by the on-board computer ^{OE}	29
ABS warnings ^{OE}	30
RDC warnings ^{OE}	32
Anti-theft alarm warnings ^{OE}	38

4 Operation 39

Ignition switch and steering lock	40
Electronic immobiliser (EWS)	41
Clock	42
Odometer and tripmeters	42
On-board computer ^{OE}	43

Tyre pressure monitoring (ReifenDruck-Control) RDC ^{OE}	48
Lights	49
Turn indicators	50
Hazard warning flashers	51
Emergency off switch (kill switch)	52
Grip heating ^{OE}	53
BMW Motorrad ABS ^{OE}	53
Clutch	54
Brakes	54
Mirrors	55
Spring preload	56
Damping	57
Tyres	58
Headlight	58
Seat	59
Helmet holder	60
5 Riding 61	
Safety instructions	62
Checklist	64
Starting	64
Running in	67

Riding off-road	68	Rims	99	Transmission	131
Brakes	68	Chain.....	99	Running gear.....	132
Parking your motorcycle	70	Wheels	101	Brakes	132
Refuelling	71	Front-wheel stand.....	106	Wheels and tyres.....	133
6 Engineering details.....	73	Bulbs.....	108	Electrics	135
Brake system with BMW Motorrad ABS ^{OE}	74	Air filter.....	114	Frame	137
Tyre pressure monitoring RDC ^{OE}	76	Jump starting	115	Dimensions	137
7 Accessories	79	Battery	116	Weights	138
General instructions	80	9 Care	121	Riding specifications	138
Power socket	80	Care products	122	11 Service	139
Luggage	81	Washing motorcycle.....	122	BMW Motorrad service.....	140
Case ^{OA}	83	Cleaning easily damaged components.....	122	BMW Motorrad service quality	140
Topcase ^{OA}	86	Paint care	123	BMW Motorrad Service Card: on-the-spot breakdown assistance	140
8 Maintenance	91	Protective wax coating	124	BMW Motorrad service network.....	141
General instructions	92	Laying up motorcycle	124	Maintenance work.....	141
Toolkit.....	92	Restoring motorcycle to use	124	Confirmation of maintenance work	142
Engine oil	93	10 Technical data	125	Confirmation of service.....	147
Brake system	94	Troubleshooting chart.....	126		
Brake pads	95	Threaded fasteners	127		
Brake fluid.....	96	Engine	129		
Coolant.....	97	Fuel	130		
Clutch.....	98	Engine oil	130		
Tyres.....	98	Clutch	131		

General instructions

Overview	6
Abbreviations and symbols	6
Equipment	7
Technical data	7
Currency	7

Overview

Chapter 2 of this Rider's Manual will provide you with an initial overview of your motorcycle. All maintenance and repair work on the motorcycle is documented in Chapter 11. This record of the maintenance work you have had performed on your motorcycle is a precondition for generous treatment of goodwill claims.

When the time comes to sell your BMW, please remember to hand over this Rider's Manual; it is an important part of the motorcycle.

Abbreviations and symbols



Indicates warnings that you must comply with for reasons of your safety and the safety of others, and to protect your motorcycle against damage.



Specific instructions on how to operate, control, adjust or look after items of equipment on the motorcycle.



Indicates the end of an item of information.



Instruction.



Result of an activity.



Reference to a page with more detailed information.



Indicates the end of a passage relating to specific accessories or items of equipment.



Tightening torque.



Item of technical data.

OE

Optional extra
The motorcycles are assembled complete with all the BMW optional extras originally ordered.

OA

Optional accessory
You can obtain optional accessories through your authorised BMW Motorrad dealer; optional accessories have to be retrofitted to the motorcycle.

EWS

Electronic immobiliser (Elektronische Wegfahrsicherung).

DWA

Anti-theft alarm (Diebstahlwarnanlage)

ABS

Anti-lock brake system

RDC

Tyre pressure control (Reifendruck-Control)

Equipment

When you ordered your BMW motorcycle, you chose various items of custom equipment. This Rider's Manual describes optional extras (OE) offered by BMW and selected optional accessories (OA). This explains why the manual may also contain descriptions of equipment which you have not ordered. Please note, too, that your motorcycle might not be exactly as illustrated in this manual on account of country-specific differences. If your BMW was supplied with equipment not described in this Rider's Manual, you will find these features described in separate manuals.

Technical data

All dimensions, weights and power ratings stated in the Rider's Manual are quoted to the standards and comply with the tolerance requirements of the Deutsche Institut für Normung e.V. Versions for individual countries may differ.

Currency

The high safety and quality standards of BMW motorcycles are maintained by constant development work on designs, equipment and accessories. Because of this, your motorcycle may differ from the information supplied in the Rider's Manual. Nor can BMW Motorrad entirely rule out errors and omissions. We hope you will appreciate that no claims can be entertained on the basis of the data, illustrations or descriptions in this manual.

General views

General view, left side.....	11
General view, right side	13
Underneath the seat	14
Underneath the trim panel	15
Handlebar fitting, left.....	16
Handlebar fitting, right	17
Instrument cluster	18
Headlight	19



General view, left side

- 1 Power socket (➡ 80)
- 2 Seat lock (➡ 59)
- 3 Engine-oil filler neck and oil dipstick (➡ 93)



General view, right side

- 1** Fuel filler neck (▣▣▣ 71)
- 2** Brake-fluid reservoir, rear (▣▣▣ 97)
- 3** Vehicle Identification Number (VIN) (on steering-head bearing), Type plate (on steering-head bearing)
- 4** Brake-fluid reservoir, front (▣▣▣ 96)
- 5** Coolant level indicator (behind side panel) (▣▣▣ 97), Coolant filler neck (behind side panel) (▣▣▣ 98)
- 6** Adjuster for spring preload, rear (▣▣▣ 56)
- 7** Adjuster for damping characteristic, rear suspension (▣▣▣ 57)

Underneath the seat

- 1 Location of first-aid kit (OA)
- 2 Toolkit
- 3 Payload table
- 4 Table of tyre pressures
- 5 Helmet holder (→ 60)
- 6 Rider's Manual
- 7 Tool for adjusting spring preload (→ 56)

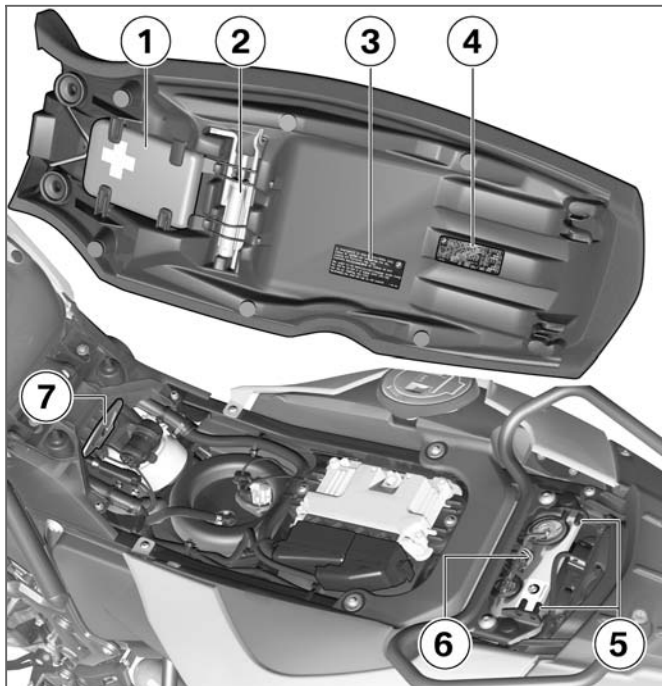

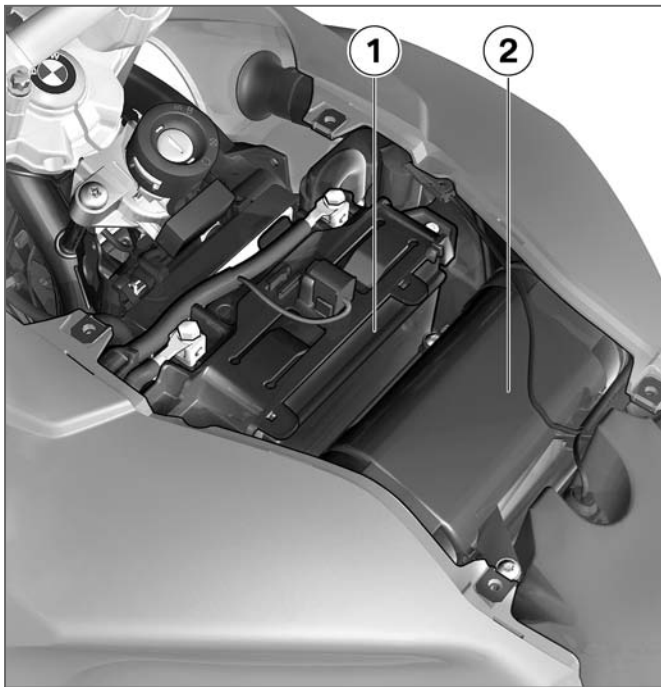

Underneath the trim panel

- 1 Battery (➡ 116)
- 2 Air-filter housing (➡ 114)

Handlebar fitting, left

- 1 Operating the on-board computer^{OE} (➔ 43)
- 2 Operating the ABS^{OE} (➔ 53)
- 3 Horn
- 4 Flashing turn indicators, left (➔ 50), Hazard warning flashers (➔ 51)
- 5 High-beam headlight and headlight flasher (➔ 49)

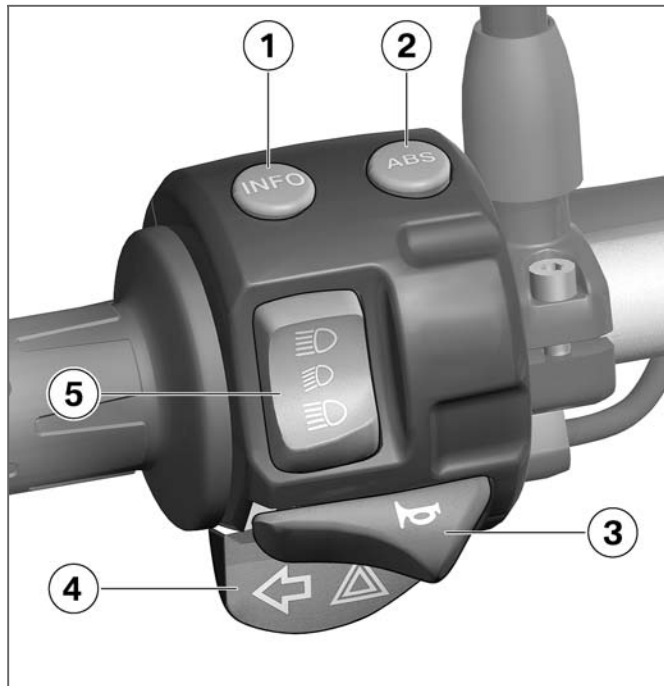

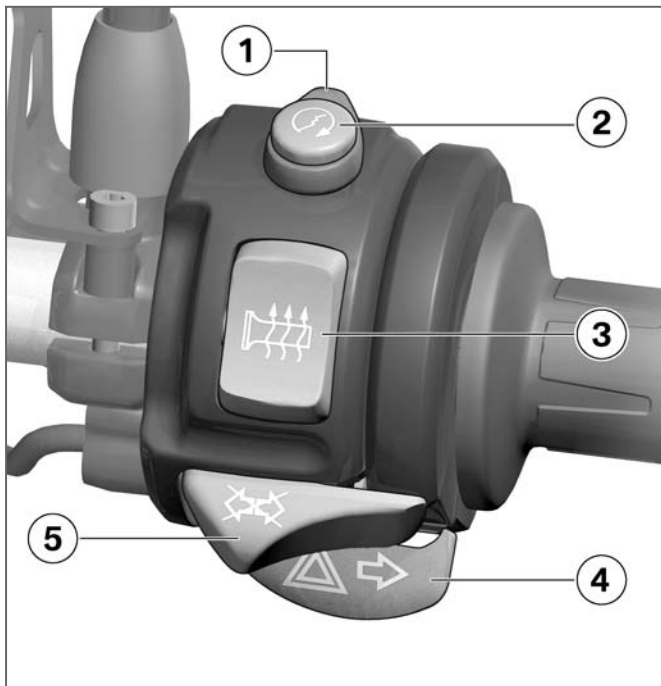

Handlebar fitting, right

- 1 Emergency off switch (kill switch) (→ 52)
- 2 Starter button (→ 65)
- 3 Grip heating^{OE} (→ 53)
- 4 Flashing turn indicators, right (→ 50), Hazard warning flashers (→ 51)
- 5 Cancel button, flashing turn indicators (→ 51), Pushbutton, cancel hazard warning flashers (→ 52)

Instrument cluster

- 1 Telltale lights (➡ 22)
- 2 Speedometer
- 3 Operation of the clock (➡ 42), Operation of the stopwatch^{OE} (➡ 46)
- 4 Multifunction display (➡ 22)
- 5 Operating the odometer (➡ 42)
- 6 Telltale light, anti-theft alarm (OE), Sensor for instrument lighting, Warning light for engine rpm^{OE} (➡ 48)
- 7 Rev. counter

▶ The instrument-cluster lighting has automatic day and night switchover. ◀

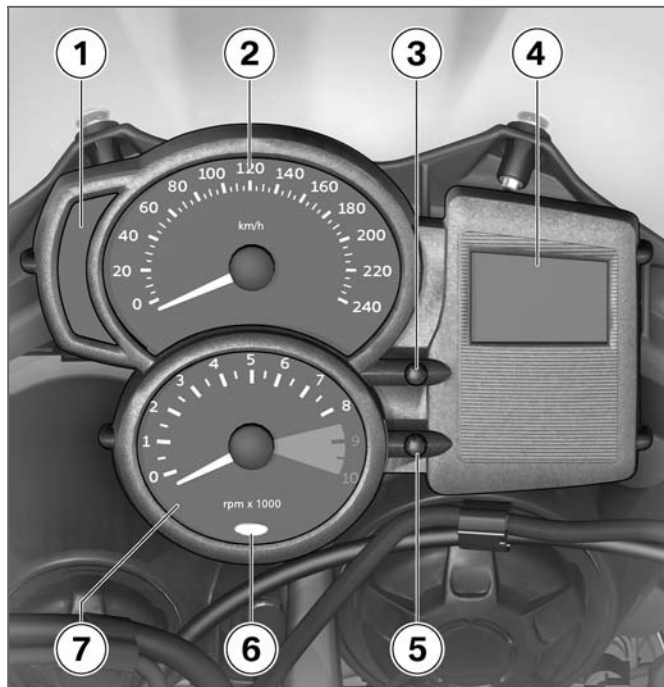

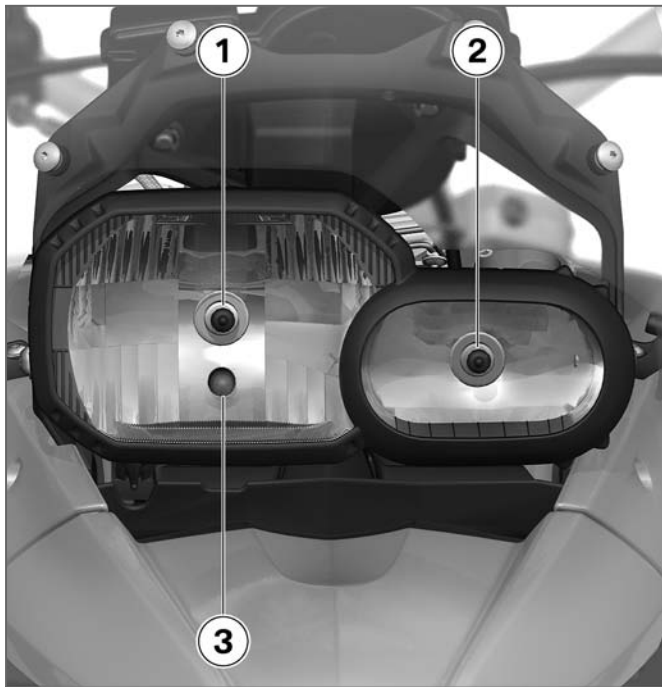

Headlight

- 1 Low-beam headlight
- 2 High-beam headlight
- 3 Side light

Status indicators

Standard status indicators	22
Status indicators with on-board computer ^{OE}	23
Status indicators with tyre-pressure monitoring (RDC) ^{OE}	24
Standard warnings	24
Warnings issued by the on-board computer ^{OE}	29
ABS warnings ^{OE}	30
RDC warnings ^{OE}	32
Anti-theft alarm warnings ^{OE}	38

Standard status indicators

Multifunction display

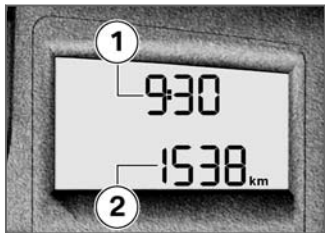

- 1 Clock (➡ 42)
- 2 Odometer and tripmeters (➡ 42)

Telltale lights

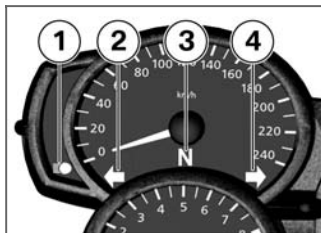

- 1 High-beam headlight
- 2 Flashing turn indicators, left
- 3 Idle
- 4 Flashing turn indicators, right

Service-due indicator

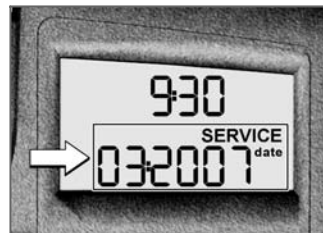

If the next service is due in less than one month, the date for the next service is shown briefly after the Pre-Ride Check completes. The month is shown as a two-digit number and the year as a four-digit number, with a colon as separator, so in this example the next service is due in March 2007.

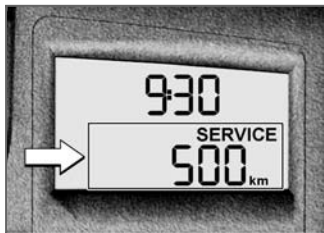

If the motorcycle covers long distances in the course of the year, under certain circumstances it might be necessary to have it serviced at a date in advance of the forecast due date. If the countdown distance to the odometer reading at which a service will be due is less than 1000 km, the distance is counted down in steps of 100 km and is shown briefly after the Pre-Ride Check completes.

If service is overdue, the due date or the odometer reading at which service was due is accom-

panied by the 'General' warning light showing yellow. The word "Service" remains permanently visible.

▶ If the service-due indicator appears more than a month in advance of the actual due date or if the word "Service" does not show permanently even though a service is overdue, the date stored in memory in the instrument cluster is incorrect and must be set. This situation can occur if the battery was disconnected for a prolonged period of time.

If you want to have the date set consult a specialist workshop, preferably an authorised BMW Motorrad dealer. ◀

Status indicators with on-board computer^{OE}

Multifunction display

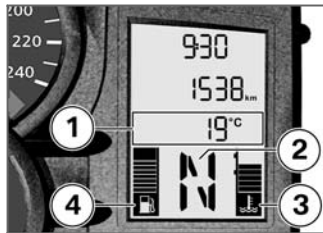

- 1 Status-indicator panel of the on-board computer^{OE} (➡ 43)
- 2 Gear indicator (➡ 23)
- 3 Coolant temperature (➡ 24)
- 4 Fuel capacity (➡ 24)

Gear indicator

N The gear engaged or N for neutral appears on the display.

N If no gear is engaged, the 'neutral' telltale light also lights up.

Coolant temperature

 The horizontal bars above the temperature symbol indicate the coolant temperature.

Fuel capacity

 The horizontal bars above the fuel-pump symbol indicate the remaining quantity of fuel. The top bar is larger than the others and the quantity of fuel it represents is correspondingly larger.

When the fuel in the tank is topped up the gauge briefly shows the original level, before the reading is updated.

Status indicators with tyre-pressure monitoring (RDC)^{OE}

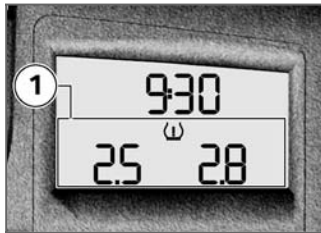

1 Temperature-compensated tyre-pressures^{OE} ( 48)

Standard warnings Mode of presentation

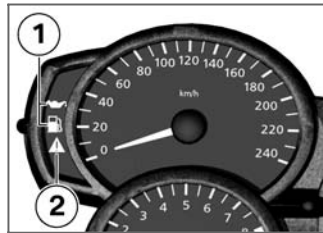

Warnings are indicated by the warning lights **1** or by the 'General' warning light **2** showing in combination with a text warning or a warning symbol in the multifunction display. The 'General' warning light shows red or yellow, depending on the urgency of the warning.

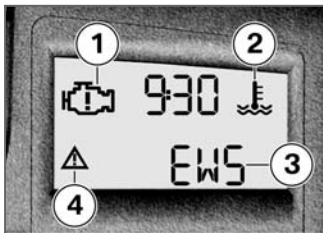

The possible warnings are listed on the next page.

Warning symbols **1** and **2** can appear on the multifunction display. Text warnings such as **3**, for example, appear in the odometer panel and are accompanied by warning-triangle symbol **4**.











If two or more warnings occur at the same time, all the appropriate warning lights and warning symbols appear. You can call up text warnings to alternate with the odometer readings (→ 42). The status of the 'General' warning light matches the most urgent warning.

Warnings, overview

Telltale lights

Status indicators

Meaning

	Lights up yellow		Appears on the display	Electronic immobiliser active (→ 27)
			EWS appears on the display.	
	Lights up			Fuel down to reserve (→ 27)
	Lights up red		Flashes	Coolant temperature too high (→ 27)
	Lights up yellow		Appears on the display	Engine in emergency-operation mode (→ 28)
	Flashes			Insufficient engine oil pressure (→ 28)
	Lights up yellow		Appears on the display	Bulb defective (→ 28)
			LAMP appears on the display.	

Electronic immobiliser active



General warning light shows yellow.



Warning-triangle symbol appears on the display.

EWS appears on the display.

Possible cause:

The key being used is not authorised for starting, or communication between key and engine electronics is disrupted.

- Remove all other vehicle keys from the same ring as the ignition key.
- Use the reserve key.
- Have the defective key replaced, preferably by an authorised BMW Motorrad dealer.

Fuel down to reserve



Warning light for fuel down to reserve shows.



Lack of fuel can result in the engine misfiring and cutting out unexpectedly. Misfiring can damage the catalytic converter; a hazardous situation can result if the engine cuts out unexpectedly.

Do not run the fuel tank dry.◀

Possible cause:

The fuel tank contains no more than the reserve quantity of fuel.

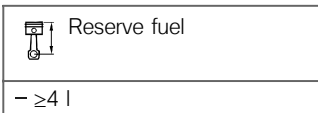

- Refuel (➡ 71)

Coolant temperature too high



General warning light shows red.



The temperature symbol flashes.



Continuing to ride when the engine is overheated could result in engine damage.

You must comply with the instructions below.◀

Possible cause:

If the coolant level is too low.

- Check the coolant level (➡ 97)

If the coolant level is too low:

- Top up the coolant (➡ 98)

Possible cause:

The coolant temperature is too high.

- If possible, ride in the part-load range to cool down the engine.
- In traffic jams, switch off the engine, but leave the ignition switched on so that the radiator or fan continues to operate.
- If the coolant temperature is frequently too high, have the fault rectified as soon as possible by a specialist workshop,

preferably an authorised BMW Motorrad dealer.

Engine in emergency-operation mode



General warning light shows yellow.



Engine symbol appears on the display.



The engine is running in emergency operating mode.

Engine power might be reduced and this can cause hazardous situations, particularly if you attempt to overtake other road users.

Engine power level might be lower than normal: adapt your style of riding accordingly. ◀

Possible cause:

The engine control unit has diagnosed a fault. In exceptional cases, the engine stops and refuses to start. Otherwise, the en-

gine runs in emergency operating mode.

- You can continue to ride, but bear in mind that the usual engine power might not be available.
- Have the fault rectified as quickly as possible by a specialist workshop, preferably an authorised BMW Motorrad dealer.

Insufficient engine oil pressure



Warning light for engine-oil pressure flashes.

The oil pressure in the lube-oil system is too low. Stop immediately and switch off the engine.



The insufficient oil pressure warning does not fulfil the function of an oil gauge. The only way of checking whether the oil level is correct is to check with the oil dipstick. ◀

Possible cause:

The engine-oil level is too low.

- Check the engine oil level (▶▶▶ 93)

If the oil level is too low:

- Top up the engine oil (▶▶▶ 94)

Possible cause:

The engine-oil pressure is insufficient.



Riding when engine-oil pressure is low can result in engine damage.

Do not continue your journey. ◀

- Have the fault rectified as quickly as possible by a specialist workshop, preferably an authorised BMW Motorrad dealer.

Bulb defective



General warning light shows yellow.



Warning-triangle symbol appears on the display.

LAMP appears on the display.



A defective bulb places your safety at risk because it is easier for other users to oversee the motorcycle.

Replace defective bulbs as soon as possible; always carry a complete set of spare bulbs if possible. ◀

Possible cause:

Low-beam headlight, parking light, rear-light, brake-light or turn-indicator bulb defective.

- Visually inspect to ascertain which bulb is defective.
- Replacing low-beam headlight bulb (➡ 108)
- Replacing high-beam headlight bulb (➡ 109)
- Replacing parking-light bulb (➡ 110)

- Replace the brake light and rear light bulb (➡ 113)
- Replacing turn indicator bulbs, front and rear (➡ 111)

Warnings issued by the on-board computer^{OE}

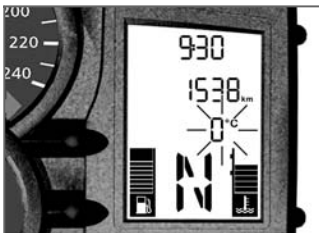

The ambient-temperature reading flashes.

Possible cause:

The air temperature measured at the motorcycle is lower than 3 °C.



The ice warning does not mean that there is no risk of black ice forming at measured temperatures above 3 °C.

Always take extra care and think well ahead when temperatures are low; remember that the danger of black ice is particularly high on bridges and where the road is in the shade. ◀

- Ride carefully and think well ahead.

ABS warnings^{OE}

Mode of presentation

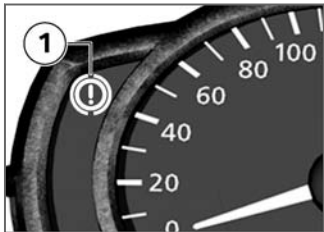

ABS warnings are indicated by ABS warning light **1**.

The way in which the ABS warning light indicates status can differ in some countries.



Possible national variant.

The detailed descriptions relating to BMW Motorrad ABS start on page (➔ 74), and you will find an overview listing the possible warnings on the next page.

Warnings, overview

Telltale lights

Status indicators

Meaning



Flashes

Self-diagnosis not completed (→ 32)



Lights up

ABS deactivated (→ 32)



Lights up

ABS fault (→ 32)

Self-diagnosis not completed



ABS warning light flashes.

Possible cause:

The ABS function is not available, because self-diagnosis did not complete. The motorcycle has to move forward a few metres for the wheel sensors to be tested.

- Pull away slowly. Bear in mind that the ABS function is not available until self-diagnosis has completed.

ABS deactivated



ABS warning light shows.

Possible cause:

The rider has switched off the ABS system.

– with BMW Motorrad ABS^{OE}

- Activate the ABS function (➡ 54)

ABS fault



ABS warning light shows.

Possible cause:

The ABS control unit has detected a fault. The ABS function is not available.

- You can continue to ride. Bear in mind that the ABS function is not available. Bear in mind the more detailed information on situations that can lead to an ABS fault (➡ 75).
- Have the fault rectified as quickly as possible by a specialist workshop, preferably an authorised BMW Motorrad dealer.

RDC warnings^{OE}

Mode of presentation

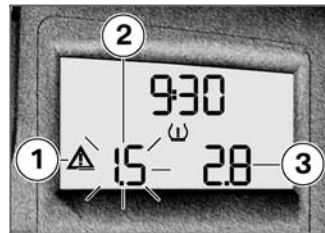

Warning symbol **1** indicates a critical tyre pressure, and the corresponding reading for the front tyre pressure **2** or the rear tyre pressure **3** flashes.



If the critical value is close to the limit of the permissible tolerance range, the reading is accompanied by the 'General' warning light showing yellow. If the tyre pressure registered by the sensor is outside the per-

missible tolerance range, the 'General' warning light shows red.









The detailed descriptions relating to BMW Motorrad RDC start on page (➡ 76), and you will find an overview listing the possible warnings on the next page.

Warnings, overview

Telltale lights

Status indicators

Meaning

	Lights up yellow		Appears on the display	Tyre pressure close to limit of permitted tolerance (➡ 36)
			The critical tyre pressure flashes	
	Flashes red		Appears on the display	Tyre pressure outside permitted tolerance (➡ 36)
			The critical tyre pressure flashes	
			"--" or "-- --" appears on the display	Signal transmission disrupted (➡ 36)
	Lights up yellow		Appears on the display	Sensor defective or system error (➡ 37)
			"--" or "-- --" appears on the display	
	Lights up yellow		Appears on the display	Battery of tyre-pressure sensor weak (➡ 37)

Telltale lights

Status indicators

Meaning

RdC appears on the display.

Battery of tyre-pressure sensor weak
( 37)

Tyre pressure close to limit of permitted tolerance



General warning light shows yellow.



Warning-triangle symbol appears on the display.

The critical tyre pressure flashes.
Possible cause:

Measured tyre pressure is close to the limit of permitted tolerance.

- Correct the tyre pressure as stated on the inside cover of the Rider's Manual.

▶ Before you adjust tyre pressure, read the information on temperature compensation and adjusting pressure in the section entitled "Engineering details".◀

Tyre pressure outside permitted tolerance



General warning light flashes red.



Warning-triangle symbol appears on the display.

The critical tyre pressure flashes.
Possible cause:

Measured tyre pressure is outside permitted tolerance.

- Check the tyre for damage and to ascertain whether the motorcycle can be ridden with the tyre in its present condition.

If the motorcycle can be ridden with the tyre in its present condition:



Incorrect tyre pressures impair the motorcycle's handling characteristics.

If tyre pressure is incorrect it is essential to adapt your style of riding accordingly.◀

- Correct the tyre pressure at the earliest possible opportunity.
- Have the tyre checked for damage by a specialist workshop, preferably an authorised BMW Motorrad dealer.

If you are unsure whether the motorcycle can be ridden with the tyre in its present condition:

- Do not continue your journey.
- Notify the breakdown service.
- Have the tyre checked for damage by a specialist workshop, preferably an authorised BMW Motorrad dealer.

Signal transmission disrupted

"- -" or "- - - -" appears on the display.

Possible cause:

The motorcycle has not yet accelerated past the threshold of approximately 30 km/h. The RDC sensors do not start transmitting signals until the motorcycle reaches a speed above this threshold (➡ 76).

- Increase speed above this threshold observe the RDC readings. Assume that a permanent fault has not occurred unless the 'General' warning light comes on to accompany the symptoms. Under these circumstances:
- Have the fault rectified by a specialist workshop, preferably an authorised BMW Motorrad dealer.

Possible cause:

Wireless communication with the RDC sensors has been disrupted. Possible causes include radio-communication systems operat-

ing in the vicinity and interfering with the link between the RDC control unit and the sensors.

- Move to another location and observe the RDC readings. Assume that a permanent fault has not occurred unless the 'General' warning light comes on to accompany the symptoms. Under these circumstances:
- Have the fault rectified by a specialist workshop, preferably an authorised BMW Motorrad dealer.

Sensor defective or system error



General warning light shows yellow.



Warning-triangle symbol appears on the display.

"--" or "-- --" appears on the display.

Possible cause:

Motorcycle is fitted with wheels not equipped with RDC sensors.

- Fit wheels and tyres equipped with RDC sensors.

Possible cause:

One or two RDC sensors have failed.

- Have the fault rectified by a specialist workshop, preferably an authorised BMW Motorrad dealer.

Possible cause:

A system error has occurred.

- Have the fault rectified by a specialist workshop, preferably an authorised BMW Motorrad dealer.

Battery of tyre-pressure sensor weak



General warning light shows yellow.



Warning-triangle symbol appears on the display.

RdC appears on the display.



This error message appears only briefly after the pre-ride check completes.◀

Possible cause:

The integral battery in the tyre-pressure sensor has lost a significant proportion of its original capacity. There is no assurance of how long the tyre pressure monitoring system can remain operational.

- Seek the advice of a specialist workshop, preferably an authorised BMW Motorrad dealer.

Anti-theft alarm warnings^{OE}



General warning light shows yellow.



The text warning dWA appears, accompanied by a warning-triangle symbol to indicate that this is a warning.



This error message appears only briefly after the pre-ride check completes.◀

Possible cause:

The integral battery in the anti-theft alarm has lost its entire original capacity. There is no assurance that the anti-theft alarm will be operational if the motorcycle's battery is disconnected.

- Seek the advice of a specialist workshop, preferably an authorised BMW Motorrad dealer.

Operation

Ignition switch and steering lock	40	Mirrors	55
Electronic immobiliser (EWS)	41	Spring preload	56
Clock	42	Damping	57
Odometer and tripmeters	42	Tyres	58
On-board computer ^{OE}	43	Headlight	58
Tyre pressure monitoring (ReifenDruck-Control) RDC ^{OE}	48	Seat	59
Lights	49	Helmet holder	60
Turn indicators	50		
Hazard warning flashers	51		
Emergency off switch (kill switch)	52		
Grip heating ^{OE}	53		
BMW Motorrad ABS ^{OE}	53		
Clutch	54		
Brakes	54		

Ignition switch and steering lock

Keys

You receive one master key and one spare key. Please consult the information on the electronic immobiliser (EWS) if a key is lost or mislaid (►► 41).

Ignition switch and steering lock, tank filler cap lock and seat lock are all operated with the same key.

- with case^{OA}
- with topcase^{OA}

If you wish you can arrange to have the cases and the top-case fitted with locks that can be opened with this key as well. Consult a specialist workshop, preferably an authorised BMW Motorrad dealer.<

Switching on ignition

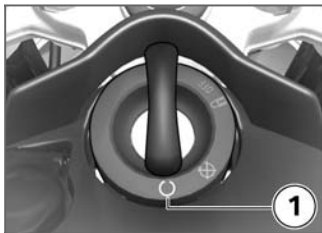

- Turn the key to position **1**.
 - » Side light and all function circuits switched on.
 - » Engine can be started.
 - » Pre-ride check is performed. (►► 65)
- with BMW Motorrad ABS^{OE}
 - Turn the key to position **1**.
 - » ABS self-diagnosis is performed in addition to the checks outlined above. (►► 66)<

Switching off ignition

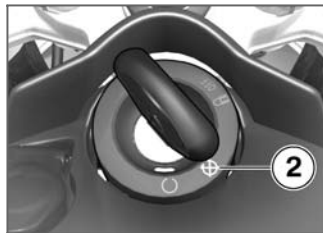

- Turn the key to position **2**.
 - » Lights switched off.
 - » Handlebars not locked.
 - » Key can be removed.
 - » Electrically powered accessories remain operational for a limited period of time.
 - » The battery can be recharged via the on-board socket.

Locking handlebars



- Turn the handlebars all the way to the left
- Turn the key to position **3**, while moving the handlebars slightly.
 - » Ignition, lights and all function circuits switched off.
 - » Handlebars locked.
 - » Key can be removed.

Electronic immobiliser (EWS)

Protection against theft

The electronic immobiliser EWS helps protect your BMW motorcycle from theft, and this enhanced security is at your disposal without any need for you to set parameters or activate additional systems. The engine of a motorcycle fitted with this electronic immobiliser can be started only with the keys that belong to the vehicle. You can also have your authorised BMW Motorrad dealer bar individual keys, for example if a particular key goes missing. The engine cannot be started with a key that has been barred.

In-key electronics

The motorcycle's electronics exchange certain continuously changing signals with the electronics in the key; these signals are specific to your motorcycle and they are transmitted via the ring aerial in the ignition lock. The ignition is not enabled for starting until the key has been recognised as "authorised" for your motorcycle.

 A spare key attached to the same ring as the ignition key used to start the engine could "irritate" the electronics, in which case the enabling signal for starting is not issued. The EWS warning appears in the multifunction display. Always keep the spare key separately from the ignition key.◀

Replacement and extra keys

You can obtain replacement/extra keys only through an authorised BMW Motorrad dealer. The keys are part of an integrated security system, so the dealer is under an obligation to check the legitimacy of all applications for replacement/extra keys. If you want to have a lost key barred, you have to bring with you all the other keys that belong to the motorcycle. A key that has been barred can subsequently be cleared and reactivated for use.

Clock

Setting clock



Attempting to set the clock while riding the motorcycle can lead to accidents.

Set the clock only when the motorcycle is stationary. ◀

- Switch on the ignition.

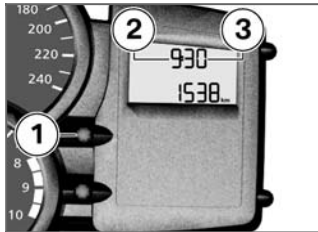

- Press and hold down button **1**.
 - » Hours reading **2** flashes.
- Press button **1**.
 - » The hours reading increments by one each time you press the button.
- Press and hold down button **1**.
 - » Minutes reading **3** flashes.
- Press button **1**.
 - » The minutes reading increments by one each time you press the button.

- Either press and hold down button **1** or wait without pressing any button.
 - » The clock is now set and the time appears on the display.

Odometer and tripmeters

Selecting readings

- Switch on the ignition.
 - with on-board computer ^{OE}

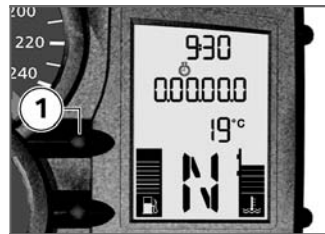

- If necessary, use button **1** to switch from the stopwatch to the odometer. ◀



- Press button **2**.



The display starts with the current value and each time the button is pressed it moves one step through the following sequence:

- Total distance covered

- Tripmeter 1 (Trip I)
- Tripmeter 2 (Trip II)
- Tyre pressures (OE)
- Warnings, if applicable

Resetting tripmeter

- Switch on the ignition.
- Select the desired tripmeter.



- Press and hold down button **2**.
- » The tripmeter is reset to zero.

On-board computer^{OE}

Selecting readings

- Switch on the ignition.



- Press button **1**.

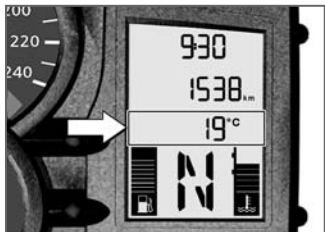

The display starts with the current value and each time the button is pressed it moves one step through the following sequence:

- Ambient temperature
- Average speed
- Average consumption
- Range

Ambient temperature

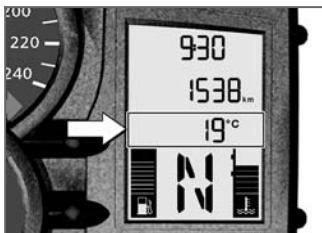

When the motorcycle is at a standstill the heat of the engine can falsify the ambient-temperature reading. If the effect of the engine's heat becomes excessive, -- temporarily appears on the display.

If ambient temperature drops below 3 °C the temperature display flashes to draw your attention to the risk of black ice forming. The display automatically switches from any other mode to the temperature reading when

the temperature drops below this threshold for the first time.

Average speed

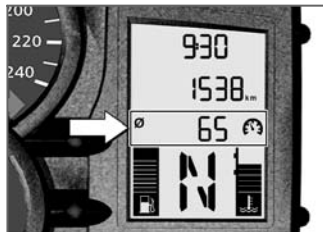

Average speed is calculated on the basis of the time elapsed since the last reset. Times during which the engine was stopped are excluded from the calculation.

Resetting average speed

- Switch on the ignition.
- Select average speed.



- Press and hold down button **1**.
» Average speed is reset to zero.

Average consumption

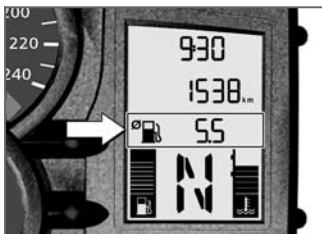

Average consumption is calculated by dividing the distance covered since the last reset by

the corresponding amount of fuel used.

Resetting average consumption

- Switch on the ignition.
- Select average consumption.



- Press and hold down button **1**.
» Average consumption is reset to zero.

Range

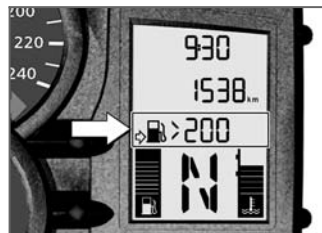

The range readout indicates how far you can ride with the fuel remaining in the tank. The figure is calculated from the level of fuel in the tank and a postulated average consumption, stored in memory, that is not always the same as the average that can be viewed on the display.

The system cannot tell exactly how much fuel is on board when the tank is completely full. Under these circumstances the display shows a minimum-range figure accompanied by a > symbol. A more accurate figure for range is

shown as soon as the fuel level can be measured exactly.

When refuelling after running on reserve, make sure that you top up the tank to a level above reserve, as otherwise the sensor will not be able to register the new level. If the sensor cannot register the new level neither the fuel-level reading nor the range readout can be updated.

▶ The calculated range is only an approximate reading. Consequently, BMW Motorrad recommends that you should not try to use the full range before refuelling. ◀

Stopwatch

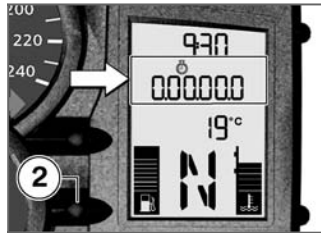

You can switch from the odometer reading to a stopwatch. The readout is in hours, minutes, seconds and tenths of a second, with dots as separators. If you want to use the stopwatch as a lap timer, you can operate it by means of the INFO button on the handlebar fitting instead of using button **2**. If you set the controls so that the stopwatch is operated by means of the INFO button, you must use button **2** to operate the on-board computer. The stopwatch continues to time in the background if you switch

back temporarily to the odometer reading. Similarly, the stopwatch continues timing if you temporarily switch off the ignition.

Operating stopwatch

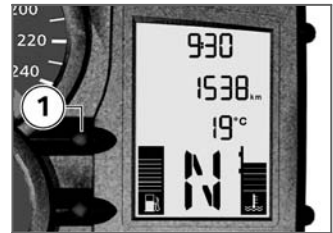

- If necessary, use button **1** to switch from the odometer to the stopwatch.

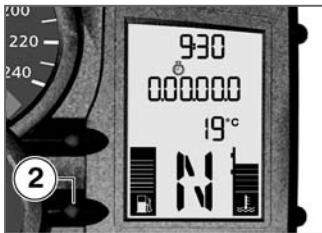

- Press button **2** while the stopwatch is stopped.
- » The stopwatch begins timing in tenths of a second from the time originally shown.
- Press button **2** while the stopwatch is running.
- » The stopwatch shows the stopped time.
- Press and hold down button **2**.
- » The stopwatch is reset and shows 0.00.00.0.

Using stopwatch as Lap-Timer

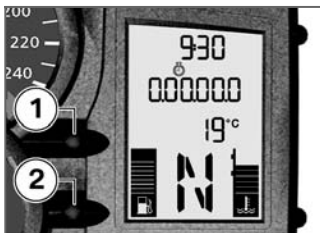

- Press button **1** and button **2** at the same time and hold them down until the reading changes.
- » FLASH (redline warning) appears, along with ON or OFF.
- Press button **2**.
- » LAP (Lap-Timer) appears, along with ON or OFF.
- Repeatedly press button **1** until the reading shows the mode you want.

- » ON: Stopwatch operated by means of the INFO button on the handlebar fitting.
- » OFF: Stopwatch operated by means of button **2** in the instrument cluster.
- To confirm the setting, press button **1** and button **2** at the same time and hold them down until the reading changes.
- » The settings are accepted and the display returns to its most recent reading.
- » The most recent setting is retained if you do not confirm the new settings.

Redline warning



The redline warning indicates that engine revolutions have reached the rev. counter's red segment. The anti-theft alarm telltale light **1** flashes red to indicate that the engine is redlining.

The signal remains active until you shift up or reduce engine speed. You can activate or deactivate the redline warning.

Activating redline warning

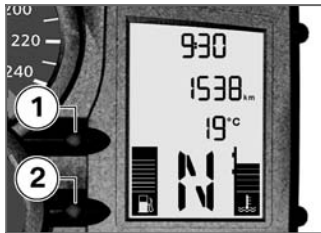

- Press button **1** and button **2** at the same time and hold them down until the reading changes.
- » FLASH (redline warning) appears, along with ON or OFF.
- Repeatedly press button **1** until the reading shows the mode you want.
- » ON: Redline warning activated.
- » OFF: Redline warning deactivated.
- To confirm the setting, press button **1** and button **2** at the same time and hold

them down until the reading changes.

- » The settings are accepted and the display returns to its most recent reading.
- » The most recent setting is retained if you do not confirm the new settings.

Tyre pressure monitoring (ReifenDruck-Control) RDC^{OE}

Selecting RDC readings

- Switch on the ignition.



- Repeatedly press button **2** until the tyre-pressure readings appear on the display.

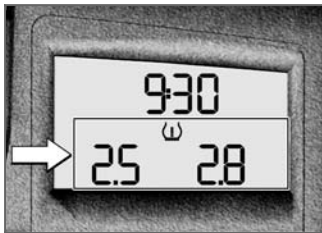

The tyre-pressure readings alternate with the odometer reading. The front tyre pressure is on the left; the reading on the

right is the rear tyre pressure. --- appears directly after the ignition is switched on, because the sensors do not transmit tyre pressures until the motorcycle accelerates to 30 km/h.



Indicates a reading for tyre pressure.

Lights

Side light

The side lights switch on automatically when the ignition is switched on.



The side lights place a strain on the battery.

Do not switch the ignition on for longer than absolutely necessary. ◀

Low-beam headlight

The low-beam headlight switches on automatically when you start the engine.



When the engine is not running you can switch on the lights by switching on the ignition and either switching on the high-beam headlight or operating the headlight flasher. ◀

High-beam headlight



- Press the top section of full-beam headlight switch **1**.
- » High-beam headlight switched on.

- Move full-beam headlight switch **1** to the centre position.
- » High-beam headlight switched off.
- Press the bottom section of full-beam headlight switch **1**.
- » The high-beam headlight is switched on until you release the button (headlight flasher).

Switching on parking lights

- Switch off the ignition.



- Immediately after switching off the ignition, press and hold

down button **1** for the left turn indicators.

- » Parking light switches on.

Switching off parking lights

- Switch the ignition on and then off again.
- » Parking lights switched off.

Turn indicators

Switching on left flashing turn indicators

- Switch on the ignition.

▶ The turn indicators are cancelled automatically after you have ridden for approximately 10 seconds, or covered a distance of about 200 m.◀



- Press button **1** for the left-hand turn indicators.
- » Left-hand turn indicators switched on.
- » Telltale light for left-hand turn indicators flashes.

Switching on right flashing turn indicators

- Switch on the ignition.

▶ The turn indicators are cancelled automatically after you have ridden for approximately 10 seconds, or covered a distance of about 200 m.◀



- Press button **2** for the right-hand turn indicators.
- » Right-hand turn indicators switched on.
- » Telltale light for right-hand turn indicators flashes.

Cancelling turn indicators



- Press cancel button **3**.
- » Flashing turn indicators switched off.
- » Turn indicator telltale lights are off.

Hazard warning flashers

Switching on hazard warning flashers

- Switch on the ignition.

▶ The hazard warning flashers place a strain on the battery. Do not use the hazard

warning flashers for longer than absolutely necessary. ◀

▶ If you press a turn-indicator button with the ignition switched on, the turn-indicator function is activated instead of the hazard warning flashers, and remains active until you release the button. The hazard warning flashers recommence flashing as soon as the button is released. ◀

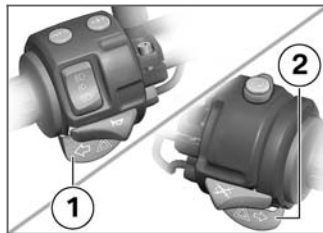

- Simultaneously press button **1** for left turn indicators and button **2** for right turn indicators.

- » The hazard warning flashers are switched on.
- » Left/right turn indicator telltale lights flash.
- Switch off the ignition.
- » The hazard warning flashers continue to operate.
- » Left and right turn indicator telltale lights are off.

Switching off hazard warning flashers



- Press cancel button **3**.
- » Hazard warning flashers switched off.

Emergency off switch (kill switch)

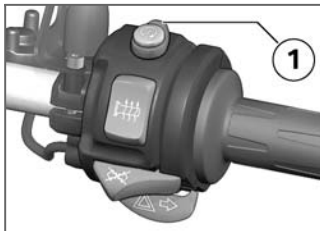

- 1** Emergency off switch (kill switch)

! Operating the kill switch when riding can cause the rear wheel to lock and thus cause a fall. Do not operate the kill switch when riding. ◀

The emergency off switch is a kill switch for switching off the engine quickly and easily.

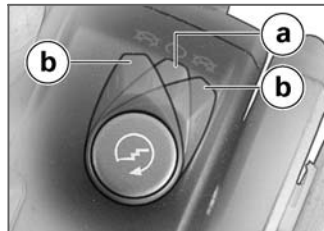

- a** Normal operating position (run)
- b** Engine switched off.

▶ You cannot start the engine unless the kill switch is in the run position. ◀

Grip heating^{OE}



1 Grip-heating switch

The handlebar grips have two-stage heating. Grip heating can be activated only when the engine is running.

▶ The increase in power consumption caused by the grip heating can drain the battery if you are riding at low engine speeds. If the charge level is low, grip heating is switched off to ensure the battery's starting capability.◀

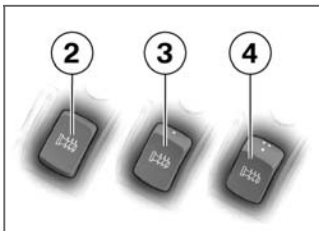



- 2 Heating off.
- 3 50 % heat output (one dot visible)
- 4 100 % heat output (three dots visible)

BMW Motorrad ABS^{OE} Deactivating ABS function

- Switch on the ignition, or bring the motorcycle to a stop.
- » The ABS function is deactivated.



- Press and hold down ABS button 1.

-  ABS warning light starts to show.
- Release the ABS button within five seconds.
-  ABS warning light remains ON.

Activating ABS function



- Press and hold down ABS button **1**.

 ABS warning light goes out; if self-diagnosis has not completed it starts flashing.

- Release the ABS button within five seconds.

 The ABS warning light remains off or continues to flash.

- » The ABS function is activated.
- Instead of pressing the ABS button, you have the option of switching the ignition off and then on again.

 If you switch the ignition off then on again and the ABS light comes back on, there is a fault in the ABS. ◀

Clutch

Adjusting clutch lever

 Attempting to adjust the clutch lever while riding the motorcycle can lead to accidents. Do not attempt to adjust the clutch lever unless the motorcycle is at a standstill. ◀

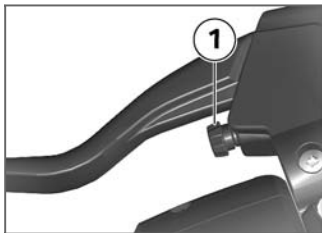

- Turn adjusting screw **1** clockwise.

 The adjusting screw is indexed and is easier to turn if you push the clutch lever forward. ◀

- » Span between handlebar grip and clutch lever increases.
- Turn adjusting screw **1** counter-clockwise.
- » Span between handlebar grip and clutch lever decreases.

Brakes

Adjusting handbrake lever

 Changing the position of the brake-fluid reservoir can allow air to penetrate the brake system.

Do not twist the handlebar fitting or the handlebars. ◀

 Attempting to adjust the brake lever while riding the motorcycle can lead to accidents. Do not attempt to adjust the

brake lever unless the motorcycle is at a standstill.◀

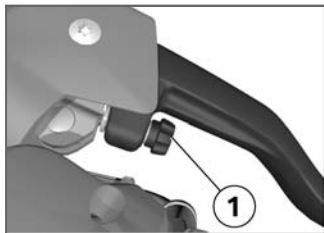

- Turn adjusting screw **1** clockwise.

▶ The adjusting screw is indexed and is easier to turn if you push the handbrake lever forward.◀

- » Span between handlebar grip and handbrake lever increases.
- Turn adjusting screw **1** counter-clockwise.
- » Span between handlebar grip and handlebar lever decreases.

Mirrors

Adjusting mirrors



- Turn the mirror to the correct position.

Adjusting mirror arm

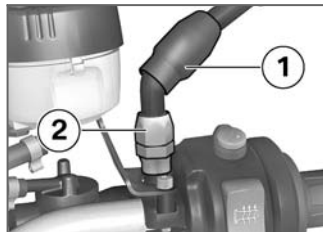

- Push protective cap **1** up over the threaded fastener on the mirror arm.
- Slacken nut **2**.
- Turn the mirror arm to the appropriate position.
- Tighten the nut to the specified tightening torque, while holding the mirror arm to ensure that it does not move out of position.



Mirror to clamping element

– 20 Nm

- Push the protective cap over the threaded fastener.

Spring preload Setting

It is essential to set spring preload of the rear suspension to suit the load carried by the motorcycle. Increase spring preload when the motorcycle is heavily loaded and reduce spring preload accordingly when the motorcycle is lightly loaded.

Adjusting spring preload for rear wheel

- Remove the seat (→ 59)

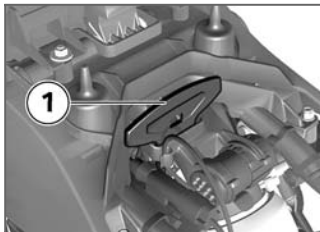

- Remove on-board toolkit **1**.

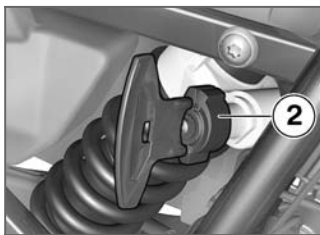

! Your motorcycle's handling will suffer if you do not match the spring-preload and damping-characteristic settings.

Adjust the damping characteristic to suit spring preload. ◀

- If you want to increase spring preload, use the tool from the on-board toolkit to turn knob **2** clockwise.
- If you want to reduce spring preload, use the tool from the on-board toolkit to turn knob **2** counter-clockwise.



Basic setting of spring preload, rear

- Turn the adjusting screw counter-clockwise as far as it will go (Full load of fuel, with rider 85 kg)

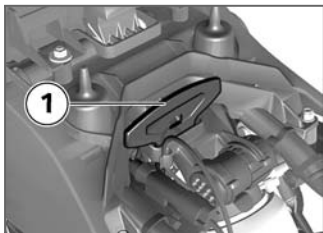

- Stow on-board toolkit **1**.
- Install the seat (➔ 60)

Damping

Damping must be adapted to suit the surface on which the motorcycle is ridden and to suit spring preload.

- An uneven surface requires softer damping than a smooth surface.
- An increase in spring preload requires firmer damping, a reduction in spring preload requires softer damping.

Adjusting damping for rear wheel

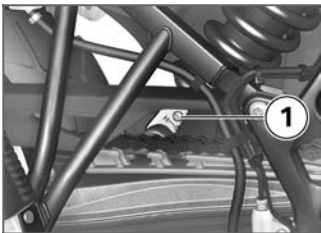

- You adjust the damping characteristic by turning adjusting screw **1**.

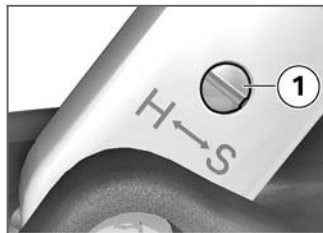

- If you want to increase damping, turn adjusting screw **1** clockwise.
- If you want to reduce damping, turn adjusting screw **1** counter-clockwise.

 Basic setting of rear-suspension damping characteristic

- Turn adjusting screw as far as it will go clockwise, then back it off 2 turns. (Full load of fuel, with rider 85 kg)

Tyres

Checking tyre pressure

- Make sure the ground is level and firm and place the motorcycle on its stand.



 Incorrect tyre pressures impair the motorcycle's handling characteristics and increase the rate of tyre wear.

Always check that the tyre pressures are correct. ◀

 At high road speeds, tyre valves have a tendency to open as a result of centrifugal force.

Fit valve caps with rubber seals and screw them on firmly to prevent sudden deflation. ◀

- Check tyre pressures against the data below.

	Tyre pressure, front
	– 2.2 bar (one-up, at tyre temperature 20 °C)
	– 2.2 bar (two-up and/or with luggage, at tyre temperature 20 °C)
	Tyre pressure, rear
	– 2.5 bar (one-up, at tyre temperature 20 °C)
	– 2.9 bar (two-up and/or with luggage, at tyre temperature 20 °C)

If tyre pressure is too low:

- Correct tyre pressure.

Headlight

Adjusting headlight for driving on left/driving on right

If the motorcycle is ridden in a country where the opposite rule of the road applies, its asymmetric low-beam headlight will tend to dazzle oncoming traffic.

Have the headlight set accordingly by a specialist workshop, preferably an authorised BMW Motorrad dealer.

Headlight beam throw and spring preload

Headlight beam throw is generally kept constant when spring preload is adjusted to suit load. Spring preload adjustment might not suffice only if the motorcycle is very heavily loaded. Under these circumstances, headlight beam throw has to be adjusted

to suit the weight carried by the motorcycle.

▶ Consult a specialist workshop, preferably an authorised BMW Motorrad dealer, if you are unsure whether the headlight basic setting is correct. ◀

Adjusting headlight beam throw

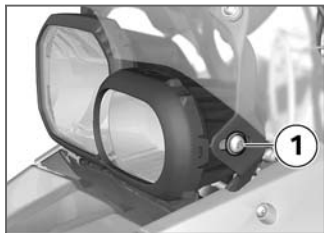

- Slacken screws **1** on left and right.
- Adjust beam throw by tilting the headlight slightly about its horizontal axis.

- Tighten screws **1** on left and right.

Beam-throw basic setting

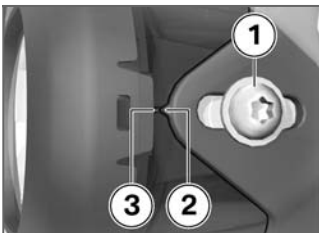

- Slacken screws **1** on left and right.
- Tilt the headlight slightly about its horizontal axis until arrowhead **2** is pointing toward marker **3**.
- Tighten screws **1** on left and right.

Seat

Removing seat

- Make sure the ground is level and firm and place the motorcycle on its stand.



- Use the ignition key to turn seat lock **1** counter-clockwise and hold it in this position.

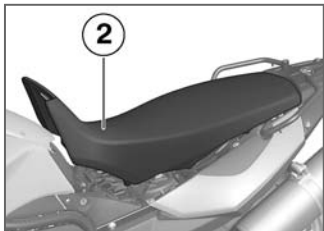

- Lift seat **2** at the front and release the key.
- Remove the seat and set it down on the rubber buffers.

Installing seat



- Engage the seat in holders **3**.

- Firmly press down on the seat at the front.
- » The seat engages with an audible click.

Helmet holder

- Remove the seat (➡ 59)



- Pass the wire rope available as an optional accessory through the helmet and slip both eyes of the wire rope over a helmet holder **1**.



! The helmet catch can scratch the panelling. Make sure the lock is out of the way when you hook the helmet into position. ◀

! If it is attached on the left side of the motorcycle, there is a possibility of the helmet being damaged by the hot end silencer.

If possible, attach the helmet on the right-hand side of the motorcycle. ◀

- Work both helmet and wire rope to the rear.
- Install the seat (➡ 60)

Riding

Safety instructions	62
Checklist.....	64
Starting	64
Running in	67
Riding off-road.....	68
Brakes	68
Parking your motorcycle	70
Refuelling	71

Safety instructions

Rider's equipment

Do not ride without the correct clothing. Always wear:

- Helmet
- Motorcycling jacket and trousers
- Gloves
- Boots

This applies even to short journeys, and to every season of the year. Your authorised BMW Motorrad dealer will be glad to advise you on the correct clothing for every purpose.

Restricted angle of heel

- with lowered suspension^{OE}

If the suspension is lowered the motorcycle's angle of heel is subject to restriction.



When a motorcycle with lowered suspension is cornering, certain components can

come into contact with the surface at an angle of heel that is less than that to which the rider is accustomed, and under certain circumstances this can result in a fall.

Carefully try out the limits of the motorcycle's angle of heel and adapt your style of riding accordingly. ◀◀

Speed

If you ride at high speed, always bear in mind that various boundary conditions can adversely affect the handling of your motorcycle:

- Settings of the spring-strut and shock-absorber system
- Imbalanced load
- Loose clothing
- Insufficient tyre pressure
- Poor tyre tread
- Etc.

Correct loading



Overloading and imbalanced loads can adversely affect the motorcycle's handling. Do not exceed the permissible gross weight and be sure to comply with the instructions on loading. ◀

Alcohol and drugs



Even small amounts of alcohol or drugs will adversely affect your perception and your ability to assess situations and make decisions, and slow down your reflexes. Medication can exacerbate these effects.

Do not ride your motorcycle after consuming alcohol, drugs and/or medication. ◀

Risk of poisoning

Exhaust fumes contain carbon monoxide, which is colourless and odourless but highly toxic.

 Inhaling the exhaust fumes therefore represents a health hazard and can even cause loss of consciousness with fatal consequences. Do not inhale exhaust fumes. Do not run the engine in an enclosed space.◀

High voltage

 Touching live parts of the ignition system with the engine running can cause electric shock. Do not touch parts of the ignition system when the engine is running.◀

Catalytic converter

If misfiring causes unburned fuel to enter the catalytic converter, there is a danger of overheating and damage.

For this reason, observe the following points:

- Do not run the fuel tank dry.
- Do not attempt to start or run the engine with a spark-plug cap disconnected.
- Stop the engine immediately if it misfires.
- Use only unleaded fuel.
- Comply with all specified maintenance intervals.

 Unburned fuel will destroy the catalytic converter. Note the points listed for protection of the catalytic converter.◀

Risk of fire

Temperatures at the exhaust are high.

 Flammable materials (e.g. hay, leaves, grass, clothing and luggage, etc.) could ignite if allowed to come into contact with the hot exhaust pipe. Do not permit flammable materials to come into contact with the hot exhaust system.◀

 Cooling would be inadequate if the engine were allowed to idle for a lengthy period with the motorcycle at a standstill: overheating would result. In extreme cases, the motorcycle could catch fire. Do not allow the engine to idle unnecessarily. Ride away immediately after starting the engine.◀

Tampering with the control unit of the electronic engine-management system



Tampering with the engine control unit can damage the motorcycle and cause accidents.

Do not tamper with the engine control unit. ◀



Tampering with the engine control unit can result in mechanical loads that the motorcycle's components are not designed to withstand. Damage caused in this way is not covered by the warranty.

Do not tamper with the engine control unit. ◀

Checklist

Use the following checklist to check important functions, settings and wear limits before you ride off.

- Brakes
- Brake-fluid levels, front and rear
- Clutch
- Damping-characteristic setting and spring preload
- Tyre-tread depth and tyre pressures
- Cases correctly installed and luggage secured

At regular intervals:

- Engine oil level (every refuelling stop)
- Brake-pad wear (every third refuelling stop)

Starting

Side stand

You cannot start the motorcycle with the side stand extended and a gear engaged. The engine will switch itself off if you start it with the gearbox in neutral and then engage a gear before retracting the side stand.

Gearbox

You can start the engine when the gearbox is in neutral or if you pull the clutch with a gear engaged. Do not pull the clutch until after you have switched on the ignition, as otherwise the engine will refuse to start. When the gearbox is in neutral, the green neutral telltale light is on and the gear indicator in the multifunction display shows N.

Starting engine

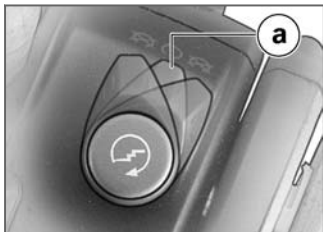

- Kill switch in run position **a**.

 Gearbox lubrication is ensured only when the engine is running. Inadequate lubrication can result in damage to the gearbox.

Do not allow the motorcycle to roll for a lengthy period of time or push it a long distance with the engine switched off. ◀

- Switch on the ignition.
 - » Pre-ride check is performed. (➡ 65)

- with BMW Motorrad ABS^{OE}
- Switch on the ignition.
 - » Pre-ride check is performed. (➡ 65)
 - » ABS self-diagnosis is performed. (➡ 66) ◀



- Press starter button **1**.

 If ambient temperatures are very low, you might find it necessary to open the throttle slightly when starting the engine. At ambient temperatures below 0 °C, disengage the clutch after switching on the ignition. ◀

 The start attempt is automatically interrupted if battery voltage is too low. Recharge the battery before you start the engine, or use jump leads and a donor battery to start. ◀

- » The engine starts.
- » If the engine refuses to start, consult the troubleshooting chart in the section entitled "Technical data". (➡ 126)

Pre-ride check

The instrument cluster runs a test of the instruments and the telltale and warning lights when the ignition is switched on. This Pre-Ride-Check, as it is known, is aborted as soon you start the engine.

Phase 1

The rev. counter and speedometer needles both swing to the limit values on their scales.

- » At the same time, the following warning lights and telltale lights are switched on in succession:
- Telltale light for high-beam headlight and left turn indicator telltale light
 - General warning light, showing yellow, and neutral telltale light
 - Warning light for fuel down to reserve and right turn indicator telltale light
 - Warning light for oil pressure
 - with BMW Motorrad ABS^{OE}
 - » ABS warning light

Phase 2

 General warning light changes from yellow to red.

Phase 3

The rev. counter and speedometer needles both swing back to rest. At the same time, all the warning lights and telltale lights switched on in the initial phase

are switched off in reverse sequence.

If a needle did not move or if a warning light or telltale light did not show as specified above:

 Some malfunctions cannot be indicated if one of the warning lights fails to show. Make sure that all the warning and telltale lights come on in the pre-ride check. ◀

- Have the fault rectified as quickly as possible by a specialist workshop, preferably an authorised BMW Motorrad dealer.

ABS self-diagnosis^{OE}

BMW Motorrad ABS performs self-diagnosis to ensure its operability. Self-diagnosis is performed automatically when you switch on the ignition. The motorcycle has to move forward a

few metres for the wheel sensors to be tested.

Phase 1

- » Test of the diagnosis-compatible system components with the motorcycle at a standstill.



ABS warning light flashes.



Possible national variant of the ABS warning light.

Phase 2

- » Test of the wheel sensors as the motorcycle pulls away from rest.



ABS warning light flashes.



Possible national variant of the ABS warning light.

ABS self-diagnosis completed

- » The ABS warning light goes out.

If an indicator showing an ABS fault appears when ABS self-diagnosis completes:

- You can continue to ride. Bear in mind that the ABS function is not available.
- Have the fault rectified as quickly as possible by a specialist workshop, preferably an authorised BMW Motorrad dealer.

Running in

The first 1000 km

- While running in the motorcycle, vary the throttle opening and engine-speed range frequently.
- Try to do most of your riding during this initial period on twisting, fairly hilly roads, avoiding high-speed main roads and highways if possible.



Exceeding the specified engine speeds while running in will lead to increased engine wear.

Keep to the specified engine speeds for running in. ◀

- Do not exceed the rpm limits recommended for running in.

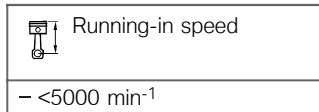

- No full-load acceleration.
- Avoid low engine speeds at full load.
- Do not omit the first inspection after 500 - 1200 km.

Brake pads

New brake pads must "bed down" and therefore do not achieve their optimum friction levels during the first 500 km. You can compensate for this initial reduction in braking

efficiency by exerting greater pressure on the levers.



New brake pads can extend stopping distance by a significant margin.

Apply the brakes in good time. ◀

Tyres

New tyres have a smooth surface. This must be roughened by riding in a restrained manner at various heel angles until the tyres are run in. This running in procedure is essential if the tyres are to achieve maximum grip.



Tyres do not have their full grip when new and there is a risk of accidents at extreme angles of heel.

Avoid extreme angles of heel. ◀

Riding off-road

Tyre pressure

 Tyre pressures reduced for off-road riding impair the motorcycle's handling characteristics on surfaced roads and can lead to accidents. Always check that the tyre pressures are correct.◀

Wheel rims for riding off-road

BMW Motorrad recommends checking the rims for damage after off-roading.

Dirt or mud on brakes

 When riding on loose surfaces or muddy roads, the brakes may fail to take effect immediately because of dirt or moisture on the discs or brake pads. Apply the brakes in good time

until the brakes have been cleaned.◀

 The brake pads will wear more rapidly if you ride frequently on unsurfaced tracks or poor roads. Check the thickness of the brake pads more frequently and replace the brake pads in good time.◀

Spring preload and shock-absorber settings

 The off-road settings for spring preload and shock absorber damping characteristic will impair the motorcycle's handling characteristics on surfaced roads. If you have been off-roading, remember to correct spring preload and shock-absorber damping characteristics before you return to surfaced roads.◀

Brakes

How can stopping distance be minimised?

Each time the brakes are applied, a load distribution shift takes place with the load shifting forward from the rear to the front wheel. The sharper the motorcycle decelerates, the more load is shifted to the front wheel. The higher the wheel load, the more braking force can be transmitted without the wheel locking. To optimise stopping distance, apply the front brakes rapidly and keep on increasing the force you apply to the brake lever. This makes the best possible use of the dynamic increase in load at the front wheel. Remember to pull the clutch at the same time. In the "panic braking situations" that are trained so frequently braking force is applied as rapidly as possible and with the

rider's full force applied to the brake levers; under these circumstances the dynamic shift in load distribution cannot keep pace with the increase in deceleration and the tyres cannot transmit the full braking force to the surface of the road. The front wheel locks and the imminent risk of a fall increases.

– with BMW Motorrad ABS^{OE} ABS has to intervene to keep the front wheel from locking; this increases stopping distance.<

Descending mountain passes

 There is a danger of the brakes fading if you use only the rear brakes when descending mountain passes. Under extreme conditions, the brakes could overheat and suffer severe damage.

Use both front and rear brakes,

and make use of the engine's braking effect as well.<

Wet brakes

 After the motorcycle has been washed, ridden through water or ridden in the rain, the brake discs and pads might be wet and the brakes might not take effect immediately.

Apply the brakes in good time until the brakes have dried out.<

Salt on brakes

 The brakes may fail to take effect immediately if the motorcycle was ridden on salt-covered roads and the brakes were not applied for some time. Apply the brakes in good time until the salt layer on the brake discs and brake pads has been removed.<

Oil or grease on brakes

 Oil and grease on the brake discs and pads considerably diminish braking efficiency.

Especially after repair and maintenance work, make sure that the brake discs and brake pads are free of oil and grease.<

Dirt or mud on brakes

 When riding on loose surfaces or muddy roads, the brakes may fail to take effect immediately because of dirt or moisture on the discs or brake pads.

Apply the brakes in good time until the brakes have been cleaned.<

 The brake pads will wear more rapidly if you ride frequently on unsurfaced tracks or poor roads.

Check the thickness of the brake

pads more frequently and replace the brake pads in good time.◀

Parking your motorcycle

Placing motorcycle on side stand

 If the ground is soft or uneven, there is no guarantee that the motorcycle will rest firmly on the stand.

Always check that the ground under the stand is level and firm.◀

- Switch off the engine.
- Pull the handbrake lever.
- Hold the motorcycle upright and balanced.
- Use your left foot to extend the side stand fully.

 The side stand is designed to support only the weight of the motorcycle.

Do not lean or sit on the

motorcycle with the side stand extended.◀

- Slowly lean the motorcycle to the side until its weight is taken by the stand and dismount to the left.

 If the motorcycle is on the side stand, the surface of the ground will determine whether it is better to turn the handlebars to the left or right. However, the motorcycle is more stable on a level surface with the handlebars turned to the left than with the handlebars turned to the right.

On level ground, always turn the handlebars to the left to set the steering lock.◀

- Turn the handlebars to full left or right lock.
- Check that the motorcycle is standing firmly.

 On a gradient, the motorcycle should always face uphill; select 1st gear.◀

- Lock the steering lock.

Removing motorcycle from side stand

- Unlock the steering lock.
- From the left, grip the handlebars with both hands.
- Pull the handbrake lever.
- Swing your right leg over the seat and lift the motorcycle to the upright position.
- Hold the motorcycle upright and balanced.

 An extended side stand can catch on the ground when the motorcycle is moving and lead to a fall.

Retract the side stand before moving the motorcycle.◀

- Sit on the motorcycle and use your left foot to retract the side stand.

Placing motorcycle on centre stand^{OE}

 If the ground is soft or uneven, there is no guarantee that the motorcycle will rest firmly on the stand.

Always check that the ground under the stand is level and firm. ◀

- Switch off the engine.
- Dismount and keep your left hand on the left handlebar grip.
- With your right hand, grip the rear grab handle or the rear frame.
- Use your right foot on the pin of the centre stand to press the stand down until its curved feet touch the ground.
- Place your full body weight on the centre stand and at the same time pull the motorcycle to the rear.

 Excessive movements could cause the centre stand to retract, and the motorcycle would topple in consequence.

Do not lean or sit on the motorcycle with the centre stand extended. ◀

- Check that the motorcycle is standing firmly.
- Lock the steering lock.

Removing motorcycle from centre stand^{OE}

- Unlock the steering lock.
- Place your left hand on the left handlebar grip.
- With your right hand, grip the rear grab handle or the rear frame.
- Push the motorcycle forward off the centre stand.
- Check that the centre stand has fully retracted.

Refuelling

 Fuel is highly flammable. A naked flame close to the fuel tank can cause a fire or explosion.

Do not smoke. Never bring a naked flame near the fuel tank. ◀

 Fuel expands when hot. Fuel escaping from an overfilled tank could make its way onto the rear tyre. This could cause a fall.

Do not fill the tank past the bottom edge of the filler neck. ◀

 Fuel attacks plastics, which become dull or unsightly. Wipe off plastic parts immediately if they come into contact with fuel. ◀

 Leaded fuel will destroy the catalytic converter. Use only unleaded fuel. ◀

- Make sure the ground is level and firm and place the motorcycle on its side stand.

 The volume of the tank can be utilised to the full only when the motorcycle is propped on its side stand. ◀



- Open the protective cap.
- Open the fuel tank cap with the ignition key by turning it counter-clockwise.



- Refuel with fuel of the grade stated below; do not fill the tank past the bottom edge of the filler neck.



Recommended fuel grade

– 91 ROZ/RON (Regular unleaded)



Usable fuel capacity

– approx. 16 l



Reserve fuel

– ≥ 4 l

- Press the fuel tank cap down firmly to close.
- Remove the key and close the protective cap.

Engineering details

Brake system with BMW Motorrad ABS ^{OE}	74
Tyre pressure monitoring RDC ^{OE}	76

Brake system with BMW Motorrad ABS^{OE}

How does ABS work?

The amount of braking force that can be transferred to the road depends on factors that include the coefficient of friction of the road surface. Loose stones, ice and snow or a wet road all have much lower coefficients of friction than a clean, dry asphalt surface. The lower the coefficient of friction, the longer the braking distance.

If the rider increases braking pressure to the extent that braking force exceeds the maximum transferrable limit, the wheels start to lock and the motorcycle loses its directional stability; a fall is imminent. Before this situation can occur, ABS intervenes and adapts braking pressure to the maximum transferrable braking force, so the wheels continue

to turn and directional stability is maintained irrespective of the condition of the road surface.

What are the effects of surface irregularities?

Humps and surface irregularities can cause the wheels to lose contact temporarily with the road surface; if this happens the braking force that can be transmitted to the road can drop to zero. If the brakes are applied under these circumstances the ABS has to reduce braking force to ensure that directional stability is maintained when the wheels regain contact with the road surface. At this instant the BMW Motorrad ABS must assume an extremely low coefficient of friction, so that the wheels will continue to rotate under all imaginable circumstances, because this is the precondition for ensuring directional stability. As soon as

it registers the actual circumstances, the system reacts instantly and adjusts braking force accordingly to achieve optimum braking.

Rear wheel lift

Under very severe and sudden deceleration, however, under certain circumstances it is possible that the BMW Motorrad ABS will be unable to prevent the rear wheel from lifting clear of the ground. If this happens the outcome can be a highside situation in which the motorcycle can flip over.



Severe braking can cause the rear wheel to lift off the ground.

When you brake, bear in mind that ABS control cannot be relied on in all circumstances to prevent the rear wheel from lifting clear of the ground. ◀

What is the design baseline for BMW Motorrad ABS?

Within the limits imposed by physics, BMW Motorrad ABS ensures directional stability on any surface. The system is not optimised for special requirements that apply under extreme competitive situations off-road or on the track.

Special situations

The speeds of the front and rear wheels are compared as one means of detecting a wheel's incipient tendency to lock. If the system registers implausible values for a lengthy period the ABS function is deactivated for safety reasons and an ABS fault message is issued. Self-diagnosis has to complete before fault messages can be issued.

In addition to problems with the BMW Motorrad ABS, exceptional

riding conditions can lead to a fault message being issued.

Exceptional riding conditions:

- Riding for a lengthy period with the front wheel lifted off the ground (wheelie).
- Rear wheel rotating with the motorcycle held stationary by applying the front brake (burn-out).
- Heating up with the motorcycle on the centre stand or an auxiliary stand, engine idling or with a gear engaged.
- Rear wheel locked for a lengthy period, for example while descending off-road.

If a fault message is issued on account of exceptional riding conditions as outlined above, you can reactivate the ABS function by switching the ignition off and on again.

What significance devolves on regular maintenance?



Invariably, a technical system cannot perform beyond the abilities dictated by its level of maintenance.

In order to ensure that the BMW Motorrad ABS is always maintained in optimum condition, it is essential for you to comply strictly with the specified inspection intervals. ◀

Reserves for safety

The potentially shorter braking distances which BMW Motorrad ABS permits must not be used as an excuse for careless riding. ABS is primarily a means of ensuring a safety margin in genuine emergencies.

Take care when cornering. When you apply the brakes on a corner, the motorcycle's weight and

momentum take over and even BMW Motorrad ABS is unable to counteract their effects.

Tyre pressure monitoring RDC^{OE}

Function

A sensor integrated into each tyre measures the air temperature and the air pressure inside the tyre and transmits this information to the control unit. Each sensor has a centrifugal-force tripswitch that does not enable transmission of the measured values until the motorcycle has accelerated to about 30 km/h. The display shows -- for each tyre until the tyre-pressure signal is received for the first time. The sensors continue to transmit the measured-value signals for approximately 15 minutes after the motorcycle comes to a stop.

The control unit can administrate four sensors, so two different sets of wheels with RDC sensors can be alternated on the motorcycle. An error message is issued if wheels without sensors are fitted to a motorcycle equipped with an RDC control unit.

Temperature compensation

Tyre pressure is a temperature-sensitive variable: pressure increases as tyre temperature rises and decreases as tyre temperature drops. Tyre temperature depends on ambient temperature, on the style of riding and the duration of the ride.

The tyre-pressure readings shown by the multifunction display are temperature-compensated; the reference tyre temperature for these readings is always 20 °C. The air lines

available to the public in petrol stations and motorway service areas have gauges that do not compensate for temperature; the reading shown by a gauge of this nature is the temperature-dependent tyre pressure. In most instances, therefore, these gauge readings will not tally with the pressures shown by the multifunction display.

Tyre-pressure ranges

The RDC control unit differentiates between three air-pressure ranges, all of which are parameterised for the motorcycle:

- Air pressure within permitted tolerance.
- Air pressure close to limit of permitted tolerance.
- Air pressure outside permitted tolerance.

Pressure adaptation

Compare the RDC readings on the multifunction display with the value in the table on the inside cover of the Rider's Manual. Then use the air line to compensate for the difference between the RDC reading and the value in the table.

Example: According to the Rider's Manual, tyre pressure should be 2.5 bar, but the reading in the multifunction display is 2.3 bar. The gauge on the air line shows 2.4 bar. You must now increase tyre pressure by the 0.2 bar difference between the value in the table and the RDC reading; when the air-line gauge shows 2.6 bar, the tyre is inflated to the correct pressure.

Accessories

General instructions.....	80
Power socket	80
Luggage	81
Case ^{OA}	83
Topcase ^{OA}	86

General instructions

BMW Motorrad recommends the use of parts and accessories for your motorcycle that are approved by BMW for this purpose. Genuine BMW parts and accessories and other products which BMW has approved can be obtained from your authorised BMW Motorrad dealer, together with expert advice on their installation and use.

These parts and products have been tested by BMW for safety, function and suitability. BMW accepts product liability for them. Conversely, BMW is unable to accept any liability whatsoever for parts and accessories which it has not approved.



BMW Motorrad cannot assess each non-BMW product to determine whether it can be used on or in connection with BMW motorcycles

without constituting a safety hazard. Country-specific official authorisation does not suffice as assurance. Tests conducted by these instances cannot make provision for all operating conditions experienced by BMW motorcycles and, consequently, they are not sufficient in some circumstances.

Use only parts and accessories approved by BMW for your motorcycle. ◀

Whenever you are planning modifications, comply with all the legal requirements. Make sure that the motorcycle does not infringe national road-vehicle construction and use regulations.

Power socket

Ratings

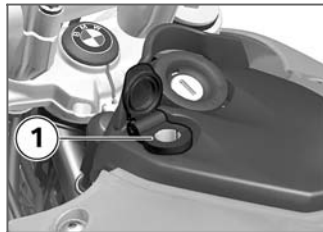

The supply to socket **1** is cut off automatically if battery voltage is low or the load exceeds the maximum rating.

Operating electrical accessories

You can start using electrical accessories only when the ignition is switched on. The accessory remains operational if the ignition is subsequently switched off. In order to ensure that the drain on the on-board power supply

system is minimised, In order to ensure that the drain on the on-board power supply system is minimised, the supply to the power socket is cut off approximately 15 minutes after the ignition is switched off, and it is also temporarily interrupted during the start procedure.

Cable routing

The cables from the power socket to the auxiliary device must be routed in such a way that they:

- Do not impede the rider
- Do not restrict or obstruct the steering angle and handling characteristics
- Cannot be trapped



Incorrectly routed cables can impede the rider. Route the cables as described above.◀

Luggage

Correct loading



Overloading and imbalanced loads can adversely affect the motorcycle's handling. Do not exceed the permissible gross weight and be sure to comply with the instructions on loading.◀

- Set spring preload, damping characteristic and tyre pressures to suit total weight.
- with case^{OA}
- Ensure that the case volumes on the left and right are equal.
- Make sure that the weight is uniformly distributed between right and left.
- Pack heavy items at the bottom of the cases and toward the inboard side.
- Note the maximum permissible payload of the cases and the

speed limit for riding with cases on the motorcycle.



Payload of cases

– max 10 kg



Maximum permissible speed for riding with cases fitted to the motorcycle

– max 160 km/h◀

– with topcase^{OA}

- Note the maximum permissible payload of the topcase and the speed limit for riding with a topcase on the motorcycle.



Payload of topcase

– max 5 kg



Maximum permissible speed for riding with top-case fitted to the motorcycle

– max 160 km/h<

– with tank rucksack ^{OA}

- Note the maximum permissible payload of the tank rucksack and the speed limit for riding with a tank rucksack on the motorcycle.



Payload of tank rucksack

– max 5 kg



Maximum permissible speed for riding with the tank rucksack fitted to the motorcycle

– max 130 km/h<

– with rear softbag ^{OA}

- Note the maximum permissible payload of the rear softbag and

the speed limit for riding with a rear softbag on the motorcycle.



Payload of rear softbag

– max 1.5 kg



Maximum permissible speed for riding with the rear softbag fitted to the motorcycle

– max 130 km/h<

Lashing luggage

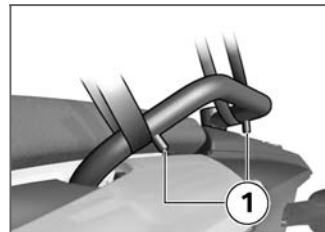

- Loop the luggage straps over the bar between the motorcycle and stops **1**.

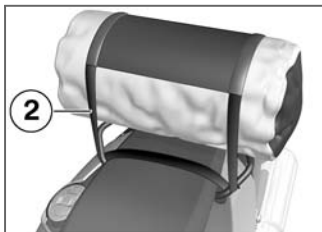

- Position luggage strap **2** as shown here with a stuffbag as example.
- Check that the luggage is secure.

Case^{OA}

Opening cases



- Turn key **1** in the case lock to right angles with the forward direction of travel.
- Hold down latch **2** and pull up carrying handle **3**.



- Press the ribbed part of rocker switch **4**.
- Hold the rocker switch down and open the lid of the case.

Closing cases



- Turn the lock with the key until it is at right angles to the forward direction of travel.
- Close case lid **1**.
 - » The lid engages with an audible click.



Closing the carry handle while the case lock is in line with the forward direction of travel can result in damage to the locking tongue.

Make sure that the case lock is at right angles to the forward direction of travel when you close the carry handle. ◀

- Push carry handle **2** down.
 - » The handle engages with an audible click.
- Turn the key in the case lock in line with the forward direction of travel and remove the key from the lock.

Adjusting case volume



- Open the case.
- Remove all its contents from the case.
- To adjust the volume of the case, engage pivot lever **1** at the top or bottom limit position, as applicable.

- » Pivot lever at top limit position: minimum volume.
- » Pivot lever at bottom limit position: maximum volume.

Removing cases



- Turn key **1** in the case lock to right angles with the forward direction of travel.
- Hold down latch **2** and pull up carrying handle **3**.

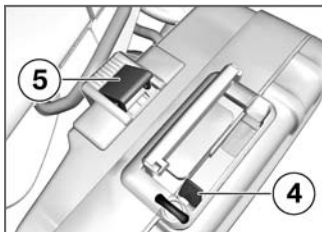

- Pull red release lever **4** up.
- » Latching flap **5** pops up.
- Fully open latching flap **5**.
- Take a grip of the carry handle and ease the case clear of the mushroom head and the curved tubular section.

Installing case



- Turn key **1** in the case lock to right angles with the forward direction of travel.
- Hold down latch **2** and pull up carrying handle **3**.

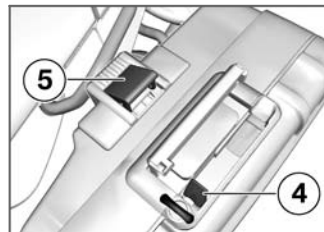

- Pull red release lever **4** up.
- » Latching flap **5** pops up.
- Fully open latching flap **5**.

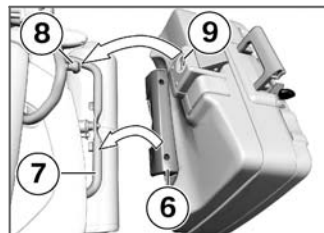

- Engage anchorage **6** on curved tubular section **7**.

- Tilt the case up and set it on mushroom head **8**, until mushroom head **8** is at the rear end of anchorage **9**.

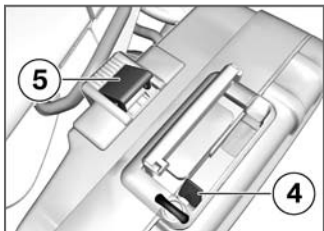

- Then push latching flap **5** down while pivoting red release lever **4** down.
 - » The latching flap engages.
- Make sure that the case is now latched in position on the mushroom head.
- Push the carry handle down until closed.
 - » The handle engages with an audible click.

- Turn the key in the case lock in line with the forward direction of travel and remove the key from the lock.

Topcase^{OA}

Opening topcase



- Turn key **1** in the topcase lock until it is at right angles to the road surface.
- Hold down latch **2** and pull out carry handle **3**.



- Press the ribbed part of rocker switch **4**.
- Hold the rocker down and open the lid of the topcase.

Closing topcase



- Turn the key in the topcase lock until it is at right angles to the road surface.
- Close topcase lid **1**.
 - » The lid engages with an audible click.



Closing the carry handle while the topcase lock is in line with the forward direction of travel can result in damage to the locking tongue.

Make sure that the topcase lock is at right angles to the forward direction of travel when you close the carry handle. ◀

- Push carry handle **2** up.
 - » The handle engages with an audible click.
- Turn the key in the topcase lock until it is parallel with the road surface and remove the key.

Adjusting topcase volume



- Open the topcase.
- Remove all its contents from the topcase.
- To adjust the volume of the topcase, engage pivot lever **1** at the front or rear limit position, as applicable.

- » Pivot lever at rear limit position (toward carry handle): minimum volume.
- » Pivot lever at front limit position (toward bottom of topcase): maximum volume.

Removing topcase



- Turn key **1** in the topcase lock until it is at right angles to the road surface.
- Hold down latch **2** and pull out carry handle **3**.

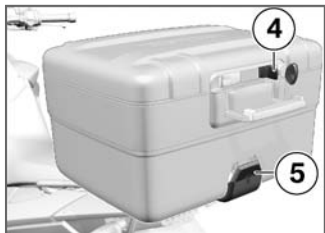

- Pull red lever **4**.
- » Latching flap **5** is unlocked.
- Fully open latching flap **5** with your hand.
- Take a firm grip of the handle and remove the topcase.

Installing topcase



- Turn key **1** in the topcase lock until it is at right angles to the road surface.
- Hold down latch **2** and pull out carry handle **3**.



- Pull red lever **4**.
- » Latching flap **5** is unlocked.
- Fully open latching flap **5** with your hand.

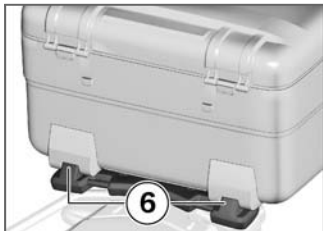

- Engage the topcase in front holders **6** of the topcase carrier plate.

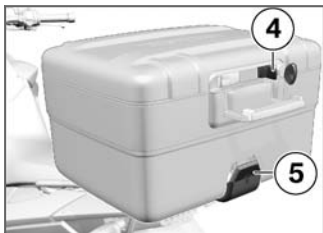

- Push the rear of the topcase onto the topcase carrier plate and engage latching flap **5**.

- Push red lever **4** in.
 - » Latching flap **5** is secured.
- Check that the topcase is secure.
- Close the carry handle and lock the topcase.

Maintenance

General instructions.....	92	Jump starting.....	115
Toolkit.....	92	Battery.....	116
Engine oil.....	93		
Brake system.....	94		
Brake pads.....	95		
Brake fluid.....	96		
Coolant.....	97		
Clutch.....	98		
Tyres.....	98		
Rims.....	99		
Chain.....	99		
Wheels.....	101		
Front-wheel stand.....	106		
Bulbs.....	108		
Air filter.....	114		

General instructions

The "Maintenance" chapter describes straightforward procedures for checking and replacing certain wear parts.

Special tightening torques are listed as applicable. The tightening torques for the threaded fasteners on your motorcycle are listed in the section entitled "Technical data".

You will find information on more extensive maintenance and repair work in the Repair Manual on DVD/CD-ROM (RepROM) for your motorcycle, which is available from your authorised BMW Motorrad dealer.

Some of the work calls for special tools and a thorough knowledge of motorcycles. If you are in doubt consult a specialist workshop, preferably your authorised BMW Motorrad dealer.

Toolkit

Toolkit

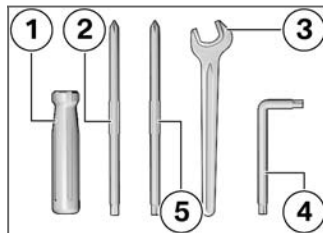

- 1 Screwdriver handle
- 2 Reversible screwdriver blade
With star-head and plain-tip ends
- 3 Open-ended spanner
Width across flats 17
- 4 Torx wrench, T40
- 5 Reversible screwdriver blade
With star-head and Torx T25

On-board toolkit service kit^{OA}

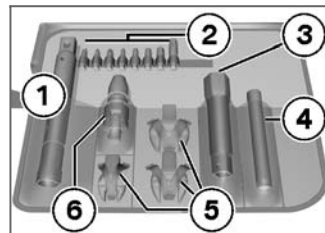

- 1 Extending tool holder
For accommodating all tools with adapters
- 2 1/4" bits
Bits of various sizes
- 3 3/8" adapter for socket-head screws, w/ 22
- 4 Electric torch
- 5 Socket
Open-ended spanners of various sizes

6 Adapter

To accommodate the 1/4" bits and the 9x12 mm and the 3/8" universal-joint adapter

Engine oil

Checking engine oil level



The engine can seize if the oil level is low, and this can lead to accidents.

Always make sure that the oil level is correct. ◀



The oil level varies with the temperature of the oil. The higher the temperature, the higher the level of oil in the sump. Checking the oil level with the engine cold or after no more than a short ride will lead to misinterpretation; this in turn, means that the engine will be operated with the incorrect quantity of oil.

In order to ensure that the engine oil level is read correctly,

check the oil level only after a lengthy trip. ◀

- Wipe the area around the oil filler neck clean.
- Allow the engine to idle until the fan starts up, then allow it to idle one minute longer.
- Switch off the ignition.
- Make sure the engine is at operating temperature and hold the motorcycle upright.
 - with centre stand^{OE}
- Check that the engine is at operating temperature, make sure the ground is level and firm and place the motorcycle on its centre stand. ◀

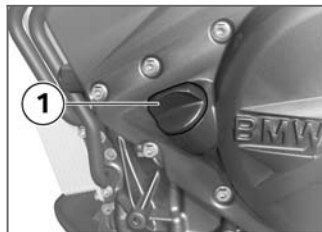

- Remove oil dipstick **1** by turning it counter-clockwise.

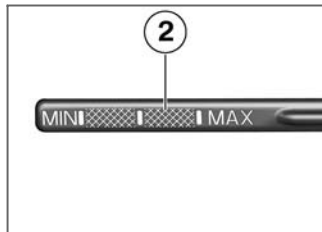

- Use a dry cloth to wipe gauge length **2** clean

- Seat the oil dipstick on the oil filler neck, but do not engage the threads.
- Remove the oil dipstick and check the oil level.

 Engine oil level
– between MIN and MAX marks on the oil dipstick
– Engine oil, 10W-40
– 0.4 l (Difference between MIN and MAX)

If the oil level is below the MIN mark:

- Top up the engine oil (➡ 94)

If the oil level is above the MAX mark:

- Have the oil level corrected by a specialist workshop, preferably an authorised BMW Motorrad dealer.

Topping up engine oil

- Check the engine oil level (➡ 93)



- Pour engine oil in through filler neck **1** until it reaches the specified level.
- Install the oil dipstick.

Brake system

Dependability of the brake system

A fully functional brake system is a basic requirement for the road safety of your motorcycle.

Do not ride the motorcycle if you have any doubts about the dependability of the brake system. Under these circumstances have the brake system checked by a specialist workshop, preferably an authorised BMW Motorrad dealer.



Incorrect working practices endanger the reliability of the brakes.

Have all work on the brake system performed by a specialist workshop, preferably an authorised BMW Motorrad dealer. ◀

Checking operation of brakes

- Pull the handbrake lever.
 - » The pressure point must be clearly perceptible.
- Press the footbrake lever.
 - » The pressure point must be clearly perceptible.

If pressure points are not clearly perceptible:

- Have the brakes checked by a specialist workshop, preferably an authorised BMW Motorrad dealer.

Brake pads

Checking brake-pad thickness, front brakes

- Make sure the ground is level and firm and place the motorcycle on its stand.

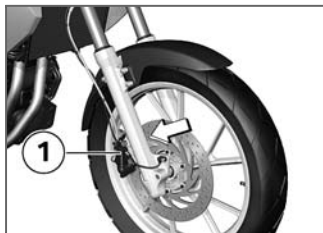

- Visually inspect the left and right brake pads to ascertain

their thickness. Viewing direction: Between wheel and fork tube toward brake caliper **1**.

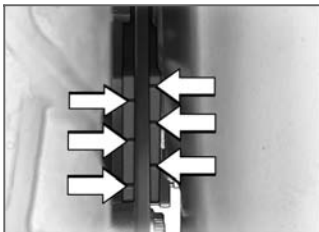

 Brake-pad wear limit, front

- min 1 mm (Friction pad only, without backing plate)
- The wear indicators (grooves) must be clearly visible.

If the wear indicating marks are no longer clearly visible:

- Have the brake pads replaced by a specialist workshop,

preferably an authorised BMW Motorrad dealer.

Checking brake pad thickness, rear brakes

- Make sure the ground is level and firm and place the motorcycle on its stand.



- Visually inspect brake pads **1** from the right to ascertain their thickness.

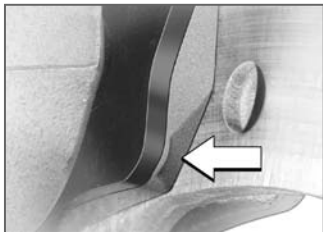

Brake-pad wear limit, rear

– min 1 mm (Friction pad only, without backing plate)

– The wear indicators must be clearly visible.

If the wear indicating mark is no longer visible:

- Have the brake pads replaced by a specialist workshop, preferably an authorised BMW Motorrad dealer.

Brake fluid

Checking brake-fluid level, front brakes

- Make sure the ground is level and firm and hold the motorcycle upright.
 - with centre stand ^{OE}
- Make sure the ground is level and firm and place the motorcycle on its centre stand. ◀
- Move the handlebars to the straight-ahead position.



- Check the brake fluid level in front reservoir **1**.

▶ Wear of the brake pads causes the brake fluid level in the reservoir to sink. ◀



Brake fluid level, front

– DOT4 brake fluid

– Do not permit the brake fluid level to drop below the MIN mark.

If the brake fluid level drops below the permitted level:

- Have the defect rectified as quickly as possible by a specialist workshop, preferably

an authorised BMW Motorrad dealer.

Checking brake-fluid level, rear brakes

- Make sure the ground is level and firm and hold the motorcycle upright.
- with centre stand^{OE}
- Make sure the ground is level and firm and place the motorcycle on its centre stand.◁

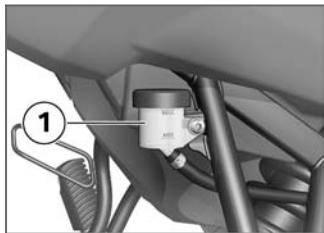

- Check the brake fluid level in rear reservoir **1**.

▶ Wear of the brake pads causes the brake fluid level in the reservoir to sink.◀



 Brake fluid level, rear
– DOT4 brake fluid
– Do not permit the brake fluid level to drop below the MIN mark.

If the brake fluid level drops below the permitted level:

- Have the defect rectified as quickly as possible by a specialist workshop, preferably

an authorised BMW Motorrad dealer.

Coolant

Checking coolant level

- Make sure the ground is level and firm and place the motorcycle on its stand.



- Check the coolant level in expansion tank **1**. Viewing direction: Between windscreen and right side panel.

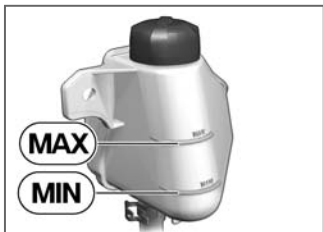

Coolant, specified level

– Antifreeze

– between MIN and MAX marks on the expansion tank

If the coolant level is too low:

- Top up the coolant.

Topping up coolant

- Turn cap of the coolant filler neck counter-clockwise to open.
- Using a suitable funnel, top up with coolant until the level is correct.

- Turn the cap of the coolant filler neck clockwise to close.

Clutch

Checking clutch operation

- Pull the clutch lever.
 - » The pressure point must be clearly perceptible.

If the pressure point is not clearly perceptible:

- Have the clutch checked by a specialist workshop, preferably an authorised BMW Motorrad dealer.

Tyres

Checking tyre tread depth



Your motorcycle's handling and grip can be impaired even before the tyres wear to the minimum tyre tread depth permitted by law.

Have the tyres changed in good time before they wear to the

minimum permissible tread depth. ◀

- Make sure the ground is level and firm and place the motorcycle on its stand.
- Measure the tyre tread depth in the main tread grooves with wear marks.



Tyres have wear indicators integrated into the main tread grooves. The tyre is worn out when the tyre tread has worn down to the level of the marks. The locations of the marks are indicated on the edge of the tyre, e.g. by the letters TI, TWI or by an arrow. ◀

If the tyre tread no longer complies with the minimum legally required tread depth:

- Replace tyre.

Rims

Visual inspection

- Make sure the ground is level and firm and place the motorcycle on its stand.
- Visually inspect the rims for defects.
- Have damaged rims checked and, if necessary, replaced by a specialist workshop, preferably an authorised BMW Motorrad dealer.

Checking spokes

- Make sure the ground is level and firm and place the motorcycle on its stand.
- Draw the handle of a screwdriver or a similar instrument across the spokes and listen to the notes of the individual spokes.

If the notes vary:

- Have the spokes checked by a specialist workshop, preferably an authorised BMW Motorrad dealer.

Chain

Lubricating chain

 Dirt, dust and inadequate lubrication will result in accelerated wear and significantly shorten the drive chain's useful life.

Clean and lubricate the drive chain at regular intervals. ◀

- Lubricate the drive chain every 1000 km at the latest. Lubricate the chain more frequently if the motorcycle is ridden in wet, dusty or dirty conditions.
- Switch the ignition off and select neutral.

- Clean the drive chain with a suitable cleaning product, dry it and apply chain lubricant.
- Wipe off excess lubricant.

Checking chain tension

- Make sure the ground is level and firm and place the motorcycle on its stand.

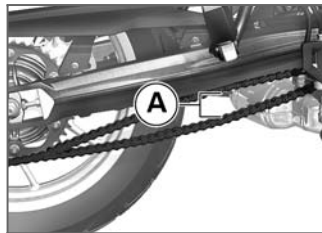

- Use a screwdriver to push the chain up and down and measure difference **A**.



Chain deflection

- 30...40 mm (Motorcycle with no weight applied, supported on its side stand)

If measured value is outside permitted tolerance:

- Adjust the chain tension (→ 100)

Adjusting chain tension

- Make sure the ground is level and firm and place the motorcycle on its stand.

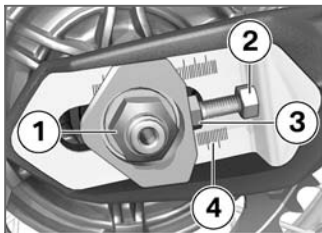

- Slacken quick-release axle nut **1**.
- Slacken locknuts **2** on left and right by turning them counter-clockwise.
- Use adjusting screws **3** on left and right to adjust chain tension.
 - » Turning screws clockwise: reduces chain tension.
 - » Turning screws counter-clockwise: increases chain tension.
- Check the chain tension (→ 99)

- Make sure that scale readings **4** are the same on left and right.
- Tighten locknuts **2** on left and right by turning them clockwise.



Locknut of the final-drive chain tensioning screw

- 19 Nm

- Tighten quick-release axle nut **1** to the specified tightening torque.



Rear quick-release axle in swinging arm

- 100 Nm

Checking chain wear

- Make sure the ground is level and firm and place the motorcycle on its stand.

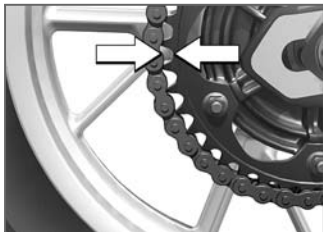

- Pull the chain back at the rearmost point of the sprocket.
- » The tips of the sprocket teeth must remain inside the chain links.

If the chain can be pulled back far enough to expose the tips of the sprocket teeth:

- Consult a specialist workshop, preferably an authorised BMW Motorrad dealer.

Wheels

Tyre recommendation

For each size of tyre BMW Motorrad tests certain makes, and approves those that it certifies as roadworthy. If BMW Motorrad has not approved the wheels and tyres, it cannot assess their suitability or provide any guarantee of road safety.

Use only wheels and tyres approved by BMW Motorrad for your type of motorcycle.

You can obtain detailed information from your authorised BMW Motorrad dealer or on the Internet at www.bmw-motorrad.com.

Effect of wheel size on suspension-control systems

Wheel size is very important as a parameter for the ABS. In particular, the diameter and the width of a motorcycle's wheels are pro-

grammed into the control unit and are fundamental to all calculations. Any change in these influencing variables, caused for example by a switch to wheels other than those installed ex-works, can have serious effects on the performance of the system.

The sensor rings are essential for correct road-speed calculation, and they too must match the motorcycle's system and consequently cannot be changed. If you decide that you would like to fit non-standard wheels to your motorcycle, it is very important to consult a specialist workshop beforehand, preferably an authorised BMW Motorrad dealer. In some cases, the data programmed into the control unit can be changed to suit the new wheel sizes.

RDC label^{OE}

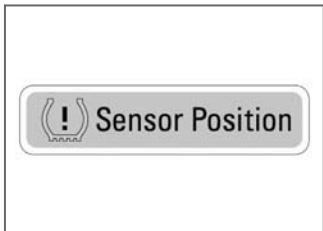

! Incorrect tyre-removal procedures can result in damage to the RDC sensors.

Be sure to notify the authorised BMW Motorrad dealer or specialist workshop that the wheel is fitted with an RDC sensor. ◀

If the motorcycle is equipped with RDC, each wheel rim bears an adhesive label indicating the position of the RDC sensor. When changing the tyre, take care not to damage the RDC sensor. Be sure to draw the attention of the authorised BMW

Motorrad dealer or specialist workshop to the fact that the wheel is fitted with an RDC sensor.

Remove the front wheel

- Place the motorcycle on a suitable auxiliary stand.
 - with centre stand^{OE}
- Make sure the ground is level and firm and place the motorcycle on its centre stand. ◀
- with BMW Motorrad ABS^{OE}



- Remove screw **1** and remove the ABS sensor from its bore. ◀

- Raise front of motorcycle until the front wheel can turn freely. BMW Motorrad recommends the BMW Motorrad front-wheel stand for lifting the motorcycle.
- Install the front wheel stand (➡ 106)



- Release axle clamping screw **2**.
- Remove axle **3**, while supporting the wheel.
- Do not remove the grease from the axle.

! Once the calipers have been removed, there is a risk of the brake pads being pressed together to the extent

that they cannot be slipped back over the brake disc on reassembly.

Do not operate the handbrake lever when the brake calipers have been removed.◀

- Roll the front wheel forward to remove.

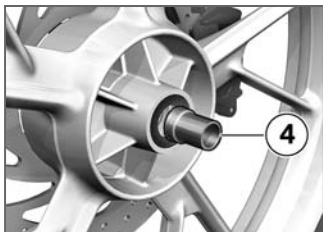

- Remove spacing bushing **4** from the left-hand side of the wheel hub.

Installing front wheel

 Threaded fasteners not tightened to the specified torque can work loose or their threads can suffer damage. Always have the security of the fasteners checked by a specialist workshop, preferably an authorised BMW Motorrad dealer.◀

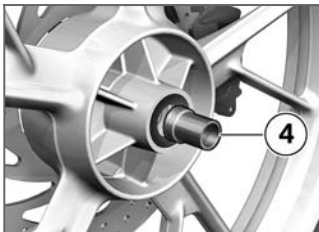

- Slip spacing bushing **4** into the left-hand side of the wheel hub.

 The front wheel must be installed right way round to rotate in the correct direction. Note the direction-of-rotation ar-

rows on the tyre or the wheel rim.◀

- Roll the front wheel into position between the forks, making sure that the brake disc passes between the brake pads.

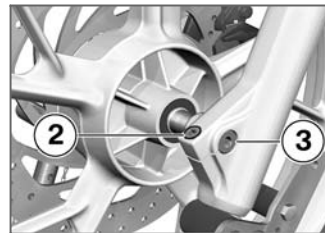

- Raise the front wheel, insert axle **3** and tighten to specified torque.



Quick-release axle, front,
in axle holder

– 30 Nm

- Remove the front-wheel stand.

- Firmly compress the front forks several times.
- Tighten axle clamping screw **2** to the specified torque.



Clamp of quick-release axle

– 19 Nm

– with BMW Motorrad ABS^{OE}

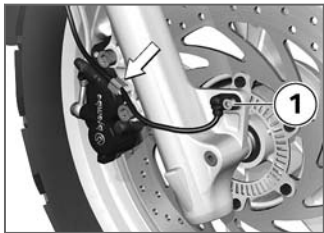

- Insert the ABS sensor into its bore and install screw **1**.

 The cable of the ABS sensor could chafe through if it comes into contact with the brake disc.

Make sure that the ABS sensor cable is routed correctly. ◀

- Make sure that the ABS sensor cable is routed as shown here. ◀
- Remove the auxiliary stand, if installed beforehand.

Removing rear wheel

- Place the motorcycle on a suitable auxiliary stand.
- with centre stand^{OE}
- Make sure the ground is level and firm and place the motorcycle on its centre stand. ◀



- Remove screw **1** of the speed sensor and remove the speed sensor from the holder.

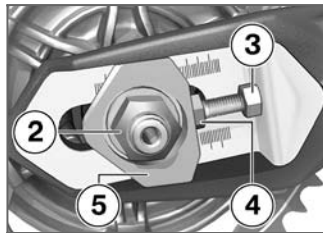

- Remove axle nut **2**.

- Slacken locknuts **3** on left and right by turning them counter-clockwise.
- Back off adjusting screws **4** on left and right by turning them counter-clockwise.
- Remove adjusting plate **5** and push the axle in as far as it will go.

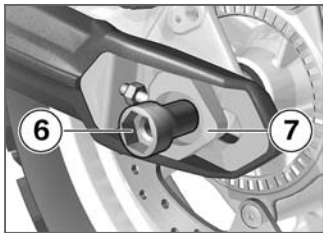

- Remove quick-release axle **6** and remove adjusting plate **7**.

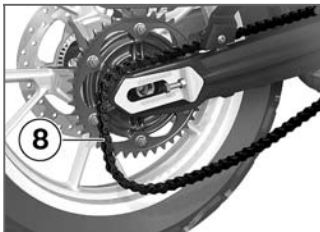

- Roll the rear wheel as far forward as possible and disengage chain **8** from the sprocket.
- Roll the rear wheel back until it is clear of the swinging arm.

▶ The sprocket and the spacer sleeves on left and right are loose fits in the wheel. Make sure that these parts are not damaged or lost on removal.◀

Installing rear wheel

- Roll the rear wheel into the swinging arm, making sure that

the brake disc passes between the brake pads.

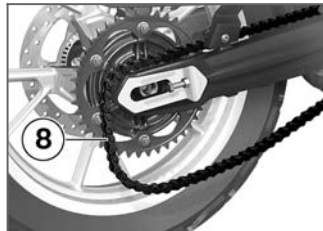

- Roll the rear wheel as far forward as possible and loop chain **8** over the sprocket.

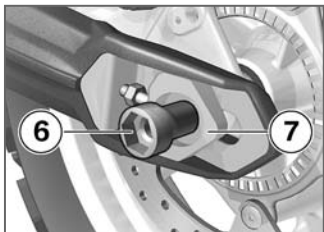

- Seat left adjusting plate **7** in the swinging arm and install quick-release axle **6** in the brake caliper and the rear wheel.
- Make sure that the axle fits into the recess of the adjusting plate.

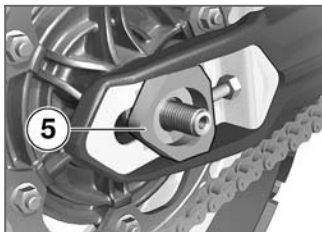

- Install right adjusting plate **5**.

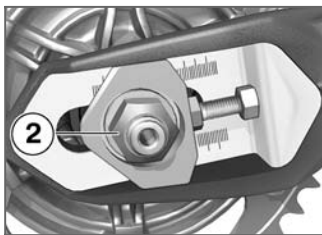

- Install nut **2**, but do not tighten it at this point.



- Seat the speed sensor in the holder and install screw **1** of the speed sensor.
- Adjust the chain tension (→ 100)
- Remove the auxiliary stand, if installed beforehand.

Front-wheel stand Installing front wheel stand



The BMW Motorrad front wheel stand is not designed to support the motorcycle without the assistance of an auxiliary stand. A motorcycle

resting only on the front wheel stand and the rear wheel can topple.

Place the motorcycle on an auxiliary stand before lifting the front wheel with the BMW Motorrad front-wheel stand. ◀

- Place the motorcycle on a suitable auxiliary stand.
– with centre stand^{OE}
- Place the motorcycle on its centre stand. ◀

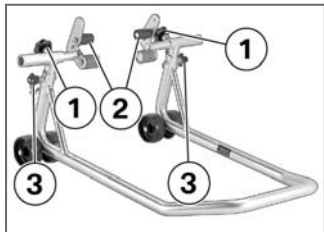

- Use basic stand (0 402 241) with front-wheel adapter (0 402 242).

- Slacken adjusting screws **1**.
- Push the two adapters **2** apart until the front forks fit between them. Adjust the adapter studs to suit the front suspension.
- Use locating pins **3** to set the front-wheel stand to the desired height.
- Centre the front-wheel stand relative to the front wheel and push it against the front axle.

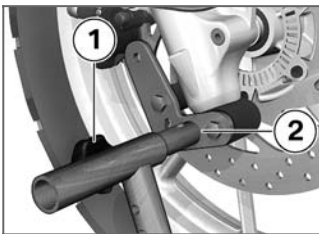

- Align the two adapters **2** so that the front forks are securely seated.
- Tighten adjusting screws **1**.



- Apply uniform pressure to push the front-wheel stand down and raise the motorcycle.

– with centre stand^{OE}

 If the motorcycle is raised too far the centre stand will lift clear of the ground and the motorcycle could topple to one side.

When raising the motorcycle, make sure that the centre stand remains on the ground. If necessary, adjust the height of the front-wheel stand. ◀

- Apply uniform pressure to push the front-wheel stand down and raise the motorcycle.◀

Bulbs

General instructions

A warning appears in the multi-function display if a bulb is defective.

 A defective bulb places your safety at risk because it is easier for other users to oversee the motorcycle.

Replace defective bulbs as soon as possible; always carry a complete set of spare bulbs if possible.◀

 The bulb is pressurised and can cause injury if damaged.

Wear protective goggles and gloves when changing bulbs.◀

 The types of bulb fitted to your motorcycle are listed in the section entitled "Technical data".◀

 Do not touch the glass of new bulbs with your fingers. Use a clean, dry cloth to hold the bulbs when handling them. Dirt deposits, in particular oil and grease, interfere with heat radiation from the bulb. This leads to overheating and shortens the bulb's operating life.◀

Replacing low-beam headlight bulb

- Make sure the ground is level and firm and place the motorcycle on its stand.



- Remove cover of low-beam headlight **1** by turning it counter-clockwise.
- Replacing low-beam and high-beam headlight bulb (➔ 109)



- Turn cover of low-beam headlight **1** clockwise to install.

Replacing high-beam headlight bulb



- Remove cover of high-beam headlight **1** by turning it counter-clockwise.
- Replacing low-beam and high-beam headlight bulb (🔧 109)



- Turn cover of high-beam headlight **1** clockwise to install.

Replacing low-beam and high-beam headlight bulb

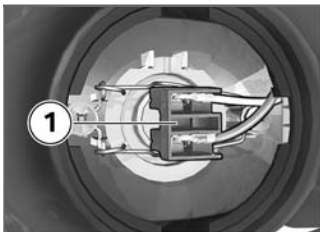

- Disconnect plug **1**.

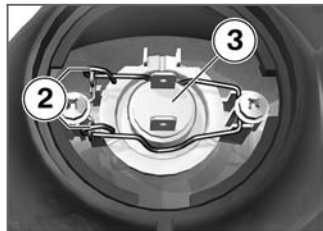

- Disengage spring clips **2** from the fastenings and swing them aside.
- Remove bulb **3**.
- Replace the defective bulb.



Bulb for low-beam headlight

– H7 / 12 V / 55 W



Bulb for high-beam headlight

– H7 / 12 V / 55 W

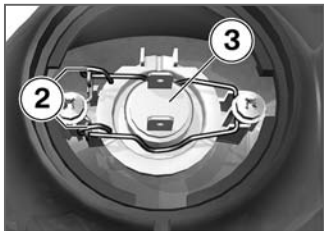

- Install bulb **3**, making sure that alignment is correct.
- Close and lock spring clips **2**.

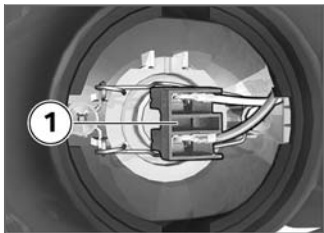

- Connect plug **1**.

Replacing parking-light bulb

- Make sure the ground is level and firm and place the motor-cycle on its stand.



- Remove cover of low-beam headlight **1** by turning it counter-clockwise.

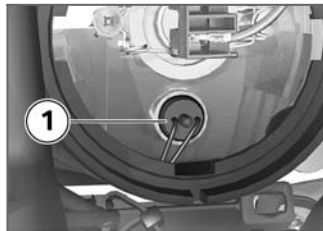

- Pull parking-light bulb **1** out of the headlight housing.

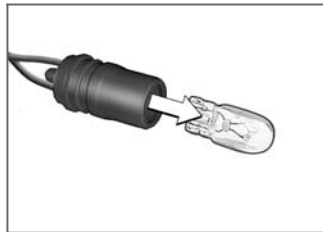

- Remove the bulb from the bulb holder.

- Replace the defective bulb.

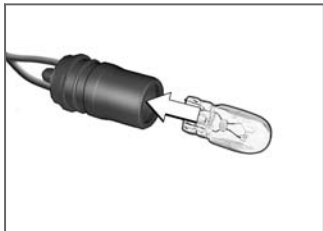
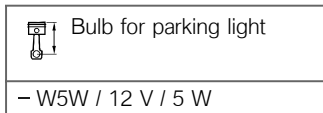

- Insert the bulb into the bulb socket.

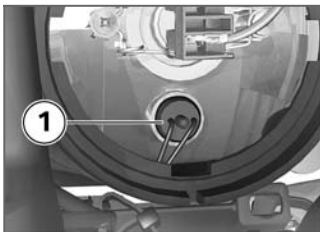

- Insert parking-light bulb **1** into the headlight housing.



- Turn cover of low-beam headlight **1** clockwise to install.

Replacing turn indicator bulbs, front and rear

- Make sure the ground is level and firm and place the motorcycle on its stand.
- Switch off the ignition.



- Remove screw **1**.

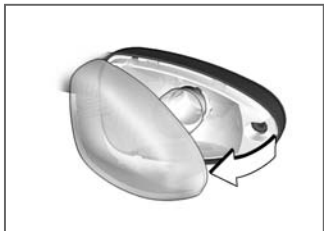

- Pull the glass out of the reflector housing at the threaded-fastener side.

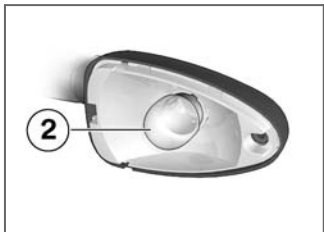

- Turn bulb **2** counter-clockwise and remove it from the bulb housing.

- Replace the defective bulb.



Bulbs for flashing turn indicators, front

– R10W / 12 V / 10 W

– with LED turn indicators ^{OA}

– LED / 12 V \leq

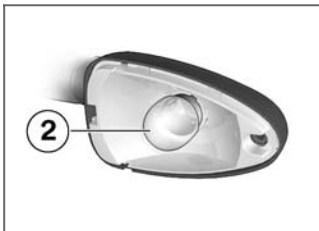

- Turn bulb **2** clockwise to install it in the bulb housing.

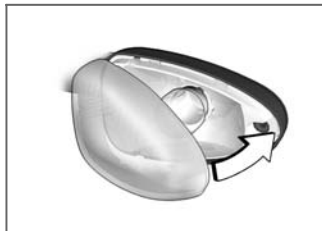

- Working from the inboard side, insert the glass into the bulb housing and close the housing.



- Install screw **1**.

Replacing brake light and rear light bulb

- The LED rear light can be replaced only as a complete unit. Consult a specialist workshop, preferably an authorised BMW Motorrad dealer.

Replacing number-plate light bulbs

- Make sure the ground is level and firm and place the motorcycle on its stand.

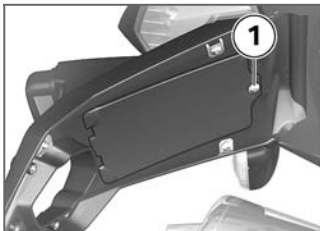

- Remove screw **1** from the mudguard cover and remove the cover.

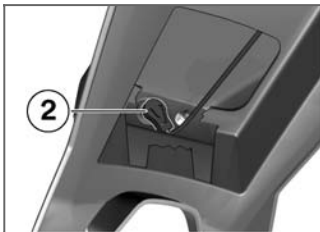

- Pull bulb holder **2** out of the light carrier.

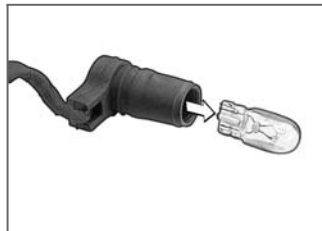

- Pull the bulb out of the bulb socket.
- Replace the defective bulb.



Bulb for number-plate light

– W5W / 12 V / 5 W

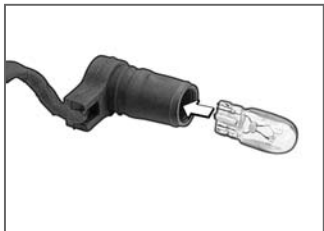

- Insert the bulb into the bulb socket.

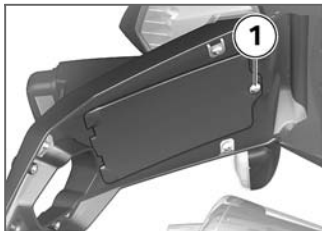

- Hold the mudguard cover in position and install screw **1**.

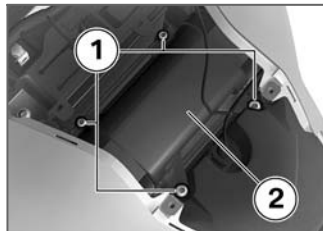

- Remove screws **1**.
- Remove air-filter cover **2**.

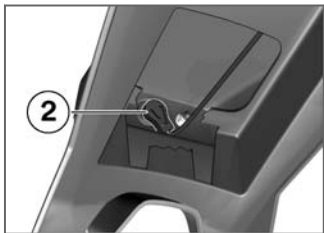

- Seat bulb holder **2** in the light carrier.

Air filter

Removing air filter

- Remove the centre trim panel (→ 119)

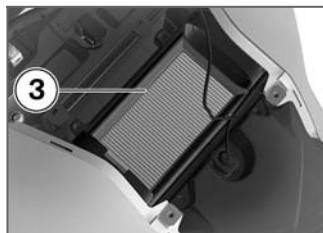

- Remove air filter **3**.

Installing air filter

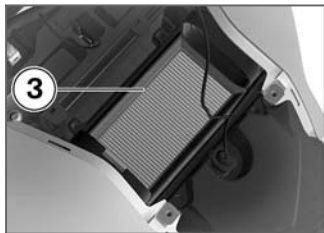

- Install air filter **3**.

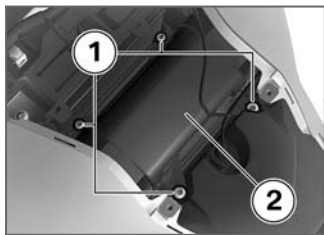

- Hold air-filter cover **2** in position.
- Install screws **1**.

- Install the centre trim panel (➔ 119)

Jump starting

 The wires leading to the power socket do not have a load-capacity rating adequate for jump-starting the engine. Excessively high current can lead to a cable fire or damage to the vehicle electronics.

Do not use the on-board socket to jump-start the engine of the motorcycle. ◀

 Touching live parts of the ignition system with the engine running can cause electric shock.

Do not touch parts of the ignition system when the engine is running. ◀

 A short-circuit can result if the crocodile clips of the jump leads are accident-

ally brought into contact with the motorcycle.

Use only jump leads fitted with fully insulated crocodile clips at both ends. ◀

 Jump-starting with a donor-battery voltage higher than 12 V can damage the vehicle electronics.

Make sure that the battery of the donor vehicle has a voltage rating of 12 V. ◀

- Remove the centre trim panel (➔ 119)
- When jump-starting the engine, do not disconnect the battery from the on-board electrical system.

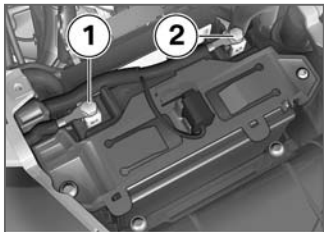

- Run the engine of the donor vehicle during jump-starting.
- Begin by connecting one end of the red jump lead to positive terminal **2** of the discharged battery and the other end to the positive terminal of the donor battery.
- Then connect one end of the black jump lead to the negative terminal of the donor battery and the other end to negative terminal **1** of the discharged battery.
- Start the engine of the vehicle with the discharged battery in the usual way; if the en-

gine does not start, wait a few minutes before repeating the attempt in order to protect the starter motor and the donor battery.

- Allow both engines to idle for a few minutes before disconnecting the jump leads.
- Disconnect the jump lead from the negative terminals **1** first, then disconnect the second jump lead from the positive terminals **2**.

 Do not use proprietary start-assist sprays or other products to start the engine. ◀

- Install the centre trim panel (▶▶▶ 119)

Battery

Maintenance instructions

Correct upkeep, recharging and storage will prolong the life of the battery and are essential if

warranty claims are to be considered.

Compliance with the points below is important in order to maximise battery life:

- Keep the surface of the battery clean and dry
- Do not open the battery
- Do not top up with water
- Be sure to read and comply with the instructions for charging the battery on the following pages
- Do not turn the battery upside down

 If the battery is not disconnected, the on-board electronics (e.g. clock, etc.) gradually drain the battery. This can cause the battery to run flat. If this happens, warranty claims will not be accepted.

If the motorcycle is to be out of use for more than four weeks, disconnect the battery or con-

nect a suitable trickle charger to the battery.◀

▷ BMW Motorrad has developed a float charger specially designed for compatibility with the electronics of your motorcycle. Using this charger, you can keep the battery charged during long periods of disuse, without having to disconnect the battery from the motorcycle's on-board systems. You can obtain additional information from your authorised BMW Motorrad dealer.◀

Charging battery when connected

 Charging the connected battery directly at the battery terminals can damage the vehicle electronics. Always disconnect the battery from the on-board circuits before recharging it with a charger

connected directly to the battery posts.◀

 Only chargers suitable for this mode of charging can be used to recharge the battery via the on-board socket. Unsuitable chargers could cause damage to the motorcycle's on-board electrics. Use BMW chargers with the part numbers 71 60 7 688 864 (220 V) or, as applicable, 71 60 7 688 865 (110 V). If you are in doubt, disconnect the battery from the on-board systems and connect the charger directly to the battery.◀

 If you switch on the ignition and the multifunction display and telltale lights fail to light up, the battery is completely flat. Attempting to charge a completely flat battery via the on-board socket can cause damage to the motorcycle's electronics.

If a battery has discharged to the extent that it is completely flat, it has to be disconnected from the on-board circuits and charged with the charger connected directly to the battery posts.◀

- Charge via the power socket, with the battery connected to the motorcycle's on-board electrical system.
- Comply with the operating instructions of the charger.

▷ The motorcycle's on-board electronics know when the battery is fully charged. The on-board socket is switched off when this happens.◀

Charging battery when disconnected

- Charge the battery using a suitable charger.
- Comply with the operating instructions of the charger.

- Once the battery is fully charged, disconnect the charger's terminal clips from the battery terminals.

▶ The battery has to be recharged at regular intervals in the course of a lengthy period of disuse. See the instructions for caring for your battery. Always fully recharge the battery before restoring it to use ◀

Remove the battery

- Remove the centre trim panel (→ 119)
- Switch off the ignition.

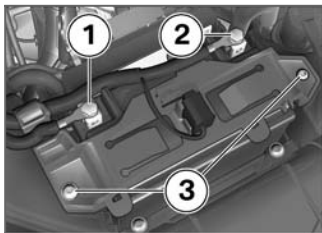

! Disconnection in the wrong sequence increases the risk of short-circuits. Always proceed in the correct sequence. ◀

- Begin by removing threaded fastener **1** of the negative lead.
- Then remove threaded fastener **2** of the positive lead.
- Remove screws **3** on left and right and remove the battery retainer.
- Lift the battery up and out; work it slightly back and forth if it is difficult to remove.

Installing battery

▶ If the battery was disconnected from the motorcycle for a prolonged period of time it will be necessary to enter the current date in the instrument cluster, in order to ensure that the service-due indicator functions correctly.

If you want to have the date set consult a specialist workshop, preferably an authorised BMW Motorrad dealer. ◀

- Insert the battery into the battery compartment, with the positive terminal on the right in the direction of travel.

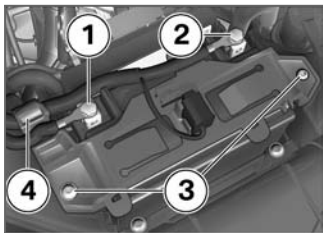

- Place the battery retainer in position, making sure that the leads are correctly routed at position **4**.
- Install screws **3** on left and right.

 Connection in the wrong sequence increases the risk of short-circuits. Always proceed in the correct sequence. ◀

- Install screw **2** securing the positive lead.
- Then install screw **1** securing the negative lead.

- Install the centre trim panel (➡ 119)
- Set the clock (➡ 42)

Removing centre trim panel

- Remove the seat (➡ 59)



- Remove screws **1** on left and right.

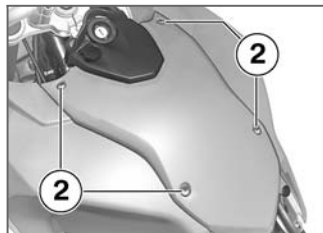

- Remove four screws **2**.
- Disconnect the plug from the socket.
- Remove the centre trim panel.

Installing centre trim panel

- Connect the plug to the socket.

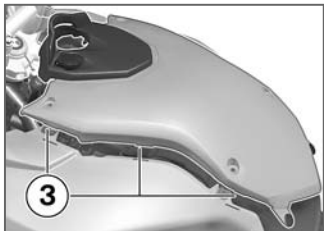

- Manoeuvre the centre trim panel into position. Make sure that all three tabs **3** on left and right engage the side panels.

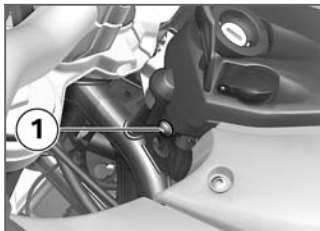

- Install screws **1** on left and right.
- Install the seat (→ 60)

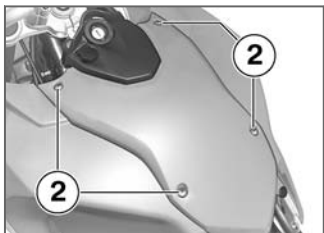

- Install four screws **2**.

Care

Care products	122
Washing motorcycle	122
Cleaning easily damaged components.....	122
Paint care.....	123
Protective wax coating	124
Laying up motorcycle.....	124
Restoring motorcycle to use	124

Care products

BMW Motorrad recommends that you use the cleaning and care products you can obtain from your authorised BMW Motorrad dealer. The substances in BMW Care Products have been tested in laboratories and in practice; they provide optimised care and protection for the materials used in your vehicle.

 The use of unsuitable cleaning and care products can damage vehicle components. Do not use solvents such as cellulose thinners, cold cleaners, fuel or the like, and do not use cleaning products that contain alcohol. ◀

Washing motorcycle

BMW Motorrad recommends that you use BMW insect remover to soften and wash off insects and stubborn dirt on

painted parts prior to washing the motorcycle.

To prevent stains, do not wash the motorcycle immediately after it has been exposed to strong sunlight and do not wash it in the sun.

Make sure that the motorcycle is washed frequently, especially during the winter months. To remove road salt, clean the motorcycle with cold water immediately after every trip.

 After the motorcycle has been washed, ridden through water or ridden in the rain, the brake discs and pads might be wet and the brakes might not take effect immediately.

Apply the brakes in good time until the brakes have dried out. ◀

 Warm water intensifies the effect of salt.

Use only cold water to wash off road salt. ◀

 The high pressure of steam cleaners can damage seals, the hydraulic brake system, the electrical system, and the seat. Do not use a steam jet or high-pressure cleaning equipment. ◀

Cleaning easily damaged components

Plastics

Clean plastic parts with water and BMW plastic care emulsion. This includes in particular:

- Windscreen and slipstream deflectors
- Headlight lens made of plastic
- Glass cover of the instrument cluster
- Black, unpainted parts

 If plastic parts are cleaned using unsuitable cleaning

agents, the surfaces can be damaged.

Do not use cleaning agents that contain alcohol, solvents or abrasives to clean plastic parts.

Even fly-remover pads or cleaning pads with hard surfaces can produce scratches.◀

 Soften stubborn dirt and insects by covering the affected areas with a wet cloth.◀

Windscreen

Clean off dirt and insects with a soft sponge and plenty of water.

 Fuel and chemical solvents attack the material of the windscreen; the windscreen becomes opaque or dull.

Do not use cleaning agents.◀

Chrome

Use plenty of water and BMW shampoo to clean chrome, particularly if it has been exposed to road salt. Use chrome polish for additional treatment.

Radiator

Clean the radiator regularly to prevent overheating of the engine due to inadequate cooling. For example, use a garden hose with low water pressure.

 Cooling fins can be bent easily.

Take care not to bend the fins when cleaning the radiator.◀

Rubber

Treat rubber components with water or BMW rubber-care products.

 Using silicone sprays for the care of rubber seals can cause damage.

Do not use silicone sprays or other care products that contain silicon.◀

Paint care

Washing the motorcycle regularly will help counteract the long-term effects of substances that damage the paint, especially if your motorcycle is ridden in areas with high air pollution or natural sources of dirt, for example tree resin or pollen.

Remove particularly aggressive substances immediately, however, as otherwise the paint can be affected or become discoloured. Substances of this nature include spilt fuel, oil, grease, brake fluid and bird droppings. We recommend BMW vehicle polish or BMW paint cleaner for this purpose.

Marks on the paintwork are particularly easy to see after the motorcycle has been washed.

Remove stains of this kind immediately, using cleaning-grade benzene or petroleum spirit on a clean cloth or ball of cotton wool. BMW Motorrad recommends BMW tar remover for removing specks of tar. Remember to wax the parts treated in this way.

Protective wax coating

BMW Motorrad recommends applying only BMW car wax or products containing carnauba wax or synthetic wax. It is time to re wax the paint-work when water "puddles" on the surface, instead of forming beads.

Laying up motorcycle

- Clean the motorcycle.
- Remove the battery.
- Spray the brake and clutch lever pivots, the side stand pivots and the centre stand pivots (if the motorcycle is fit-

ted with a centre stand) with a suitable lubricant.

- Coat bright metal and chrome-plated parts with an acid-free grease (e.g. Vaseline).
- Stand the motorcycle in a dry room in such a way that there is no load on either wheel.

▶ Before laying the vehicle up out of use, have the engine oil and the oil filter element changed by a specialist workshop, preferably an authorised BMW Motorrad dealer. Combine work for laying up/restoring to use with a BMW service or inspection. ◀

Restoring motorcycle to use

- Remove the protective wax coating.
- Clean the motorcycle.
- Install a charged battery.

- Before starting: work through the checklist.

Technical data

Troubleshooting chart	126
Threaded fasteners	127
Engine	129
Fuel.....	130
Engine oil	130
Clutch	131
Transmission	131
Running gear	132
Brakes	132
Wheels and tyres	133
Electrics	135
Frame	137
Dimensions	137
Weights.....	138
Riding specifications	138

Troubleshooting chart

Engine does not start at all or is difficult to start.

Possible cause	Remedy
Kill switch activated.	Kill switch in operating position (run).
Side stand extended and gear engaged.	Retract the side stand (➡ 64).
Gear engaged and clutch not disengaged.	Select neutral or pull clutch lever (➡ 64).
Clutch pulled when ignition was OFF	Switch on the ignition, then pull the clutch lever.
No fuel in tank.	Refuel (➡ 71)
Battery not adequately charged.	Charge the battery when connected (➡ 117)

Threaded fasteners

Front wheel	Value	Valid
Brake caliper to fork leg		
M10 x 40	38 Nm	
Clamp of quick-release axle		
M8 x 25	19 Nm	
Quick-release axle, front, in axle holder		
M16 x 1.5	30 Nm	
Rear wheel	Value	Valid
Rear quick-release axle in swinging arm		
M16 x 1.5	100 Nm	
Mirror arm	Value	Valid
Mirror to clamping element		
M14 x 1	20 Nm	

Mirror arm	Value	Valid
Clamping element to clamping block		
M10	30 Nm	
Chain	Value	Valid
Locknut of the final-drive chain tensioning screw		
M8	19 Nm	

Engine

Engine design	Two-cylinder four-stroke, DOHC with chain-and-sprocket drive, 4 valves operated by cam followers, balancing conrod, liquid-cooled cylinders and heads, integral water pump, 6-speed gearbox and dry sump lubrication
Displacement	798 cm ³
Cylinder bore	82 mm
Piston stroke	75.6 mm
Compression ratio	12 : 1
Nominal output	52 kW, - at engine speed: 7000 min ⁻¹
- with power reduction ^{OE}	25 kW, - at engine speed: 5000 min ⁻¹
Torque	75 Nm, - at engine speed: 4500 min ⁻¹
- with power reduction ^{OE}	57 Nm, - at engine speed: 3000 min ⁻¹
Maximum engine speed	max 9000 min ⁻¹
Idle speed	1250 ⁺⁵⁰ min ⁻¹

Fuel

Recommended fuel grade	91 ROZ/RON, Regular unleaded
Usable fuel capacity	approx. 16 l
Reserve fuel	≥4 l

Engine oil

Engine oil, capacity	2.9 l, with filter change
Lubricant	Engine oil, 10W-40
Oil grades	Mineral oils of API classification SF through SH. BMW Motorrad recommends not using oil additives, because they can have a detrimental effect on clutch operation. Please do not hesitate to contact your authorised BMW Motorrad dealer if you have any questions relating the choice of a suitable engine oil for your motorcycle.

Permissible viscosity classes

SAE 10 W-40	≥-20 °C, Operation at low temperatures
SAE 15 W-40	≥-10 °C

Clutch

Clutch type	Multiplate clutch running in oil bath
-------------	---------------------------------------

Transmission

Gearbox type	Claw-shift 6-speed gearbox, integrated into engine block
Gearbox transmission ratios	1.943 (35/68 teeth), Primary transmission ratio 1:2.462 (13/32 teeth), 1st gear 1:1.750 (16/28 teeth), 2nd gear 1:1.381 (21/29 teeth), 3rd gear 1:1.174 (23/27 teeth), 4th gear 1:1.042 (24/25 teeth), 5th gear 1:0.960 (25/24 teeth), 6th gear

Running gear

Front wheel

Type of front suspension	Telescopic forks
Spring travel, front	180 mm, At wheel

Rear wheel

Type of rear suspension	Two-arm cast-aluminium swinging arm
Type of rear suspension	Direct-pivot central spring strut with steplessly adjustable rebound-stage damping
Spring travel at rear wheel	170 mm, At wheel

Brakes

Front wheel

Type of front brake	Hydraulically operated disc brake with 2-piston floating caliper and fixed disc
Brake-pad material, front	Sintered metal

Rear wheel

Type of rear brake	Hydraulically operated disc brake with 1-piston floating caliper and fixed disc
Brake-pad material, rear	Organic material

Wheels and tyres

Tyre combinations recommended at time of going to press (As at: 23.08.2007)	Front: Michelin Anakee Front, 110/80 R19 M/C TL/TT (59V) Rear: Michelin Anakee, 140/80 R17 M/C TL/TT (69V)
	Front: Bridgestone BW 501 Front, 110/80 R19 M/C TL/TT (59V) Rear: Bridgestone BW 502, 140/80 R17 M/C TL/TT (69V)
	Front: Metzeler Tourance Front, 110/80 R19 M/C TL/TT (59V) Rear: Metzeler Tourance, 140/80 R17 M/C TL/TT (69V)
	You can obtain an up-to-date list of approved tyres from your authorised BMW Motorrad dealer or on the Internet at " www.bmw-motorrad.com ".

Front wheel

Front wheel, type	Cast aluminium, MT H2
Front wheel rim size	2.50" x 19"
Tyre designation, front	110/80 R 19 (59V) TL

Rear wheel

Rear wheel type	Cast aluminium, MT H2
Rear wheel rim size	3.50" x 17"
Tyre designation, rear	140/80 R 17 (69V) TL

Tyre pressure

Tyre pressure, front	2.2 bar, one-up, at tyre temperature: 20 °C 2.2 bar, two-up and/or with luggage, at tyre temperature: 20 °C
Tyre pressure, rear	2.5 bar, one-up, at tyre temperature: 20 °C 2.9 bar, two-up and/or with luggage, at tyre temperature: 20 °C

Electrics

Electrical rating of on-board socket	5 A
Fuses	Electronic fuses protect all the circuits. If an electronic fuse trips and de-energises a circuit, the circuit is active as soon as the ignition is switched on after the fault has been rectified.

Battery

Battery, manufacturer and designation	Exide ETX14-BS
Battery type	AGM (Absorbent Glass Mat) battery
Battery rated voltage	12 V
Battery rated capacity	14 Ah

Spark plugs

Spark plugs, manufacturer and designation	NGK DCPR 8 E
Electrode gap of spark plug	0.9 \pm 0 mm, When new
	max 1.2 mm, Wear limit

Lighting

Bulb for high-beam headlight	H7 / 12 V / 55 W
Bulb for low-beam headlight	H7 / 12 V / 55 W
Bulb for parking light	W5W / 12 V / 5 W
Bulb for tail light/brake light	LED / 12 V
	6 or more LEDs defective: replace the rear light
Bulb for number-plate light	W5W / 12 V / 5 W
Bulbs for flashing turn indicators, front	R10W / 12 V / 10 W
– with LED turn indicators ^{OA}	LED / 12 V
Bulbs for flashing turn indicators, rear	R10W / 12 V / 10 W
– with LED turn indicators ^{OA}	LED / 12 V

Frame

Frame type	Tubular spaceframe
Type plate location	Steering head front centre
VIN location	Steering head, right

Dimensions

Length of motorcycle	2280 mm, across front wheel to number-plate carrier
Height of motorcycle	1240 mm, Without rider at unladen weight
Width of motorcycle	845 mm, across mirrors without mirrors
Front-seat height	820 mm, Without rider at unladen weight
– with dual seat, low ^{OE}	790 mm, Without rider at unladen weight
– without lowered suspension ^{OE}	
– with lowered suspension ^{OE}	765 mm, Without rider at unladen weight
Rider's inside-leg arc, heel to heel	1820 mm
– with dual seat, low ^{OE}	1780 mm, Without rider at unladen weight
– without lowered suspension ^{OE}	
– with lowered suspension ^{OE}	1710 mm, Without rider at unladen weight

Weights

Unladen weight	199 kg, DIN unladen weight, ready for road, 90 % load of fuel
Permissible gross weight	436 kg
– with lowered suspension ^{OE}	349 kg
Maximum payload	237 kg
– with lowered suspension ^{OE}	150 kg

Riding specifications

Top speed	max 190 km/h
– with power reduction ^{OE}	max 147 km/h

Service

BMW Motorrad service	140
BMW Motorrad service quality	140
BMW Motorrad Service Card: on-the-spot breakdown assistance	140
BMW Motorrad service network ...	141
Maintenance work	141
Confirmation of maintenance work	142
Confirmation of service	147

BMW Motorrad service

Advanced technology requires specially adapted methods of maintenance and repair.



If maintenance and repair work is performed inexpertly, it could result in consequential damage and thus constitute a safety risk.

BMW Motorrad recommends you to have all the associated work on your motorcycle carried out by a specialist workshop, preferably an authorised BMW Motorrad dealer. ◀

Your authorised BMW Motorrad dealer can provide information on BMW services and the work undertaken as part of each service. Have all maintenance and repair work carried out confirmed in the "Service" chapter in this manual. Authorised BMW Motorrad dealers are supplied with the latest technical information and have

the necessary technical know-how. BMW Motorrad recommends that you contact your authorised BMW Motorrad dealer if you have questions regarding your motorcycle.

BMW Motorrad service quality

Along with its reputation for engineering quality and high reliability, BMW Motorrad is a byword for excellent quality of service.

To ensure that your BMW is always in optimum condition, BMW Motorrad recommends that you have the maintenance work required for your motorcycle carried out regularly, preferably by your authorised BMW Motorrad dealer. For generous treatment of claims submitted after the warranty period has expired, evidence of regular maintenance is essential.

Certain signs of wear, moreover, may otherwise not be noticed until it is too late to put them right at moderate cost. Your authorised BMW Motorrad dealer's mechanics know every detail of your motorcycle and can take remedial action if necessary before minor faults develop into serious problems. By having the necessary repairs done properly and in good time, you save time and money in the long run.

BMW Motorrad Service Card: on-the-spot breakdown assistance

In the event of a breakdown, the BMW Motorrad Service Card issued with each new BMW motorcycle enables you to access an extensive range of services such as breakdown assistance, motorcycle transportation etc. (details can differ from country to country). In the event of a break-

down, contact the Mobile Service organisation of BMW Motorrad. The specialists will provide the necessary advice and assistance. You will find important country-specific contact addresses and the after-sales service organisation phone numbers in the "Service Kontakt / Service Contact" brochures, along with information on Mobile Service and the dealership network.

BMW Motorrad service network

BMW Motorrad has an extensive after-sales service network in place to look after you and your motorcycle in more than 100 countries. In Germany alone, you have the best possible access to approximately 200 authorised BMW Motorrad dealers. All information concerning the international dealership network can be found in the brochure

"Service Contact Europe" or "Service Contact Africa, America, Asia, Australia, Oceania".

Maintenance work

BMW Pre-delivery Check

Your authorised BMW Motorrad dealer conducts the BMW pre-delivery check before handing over the motorcycle to you.

BMW Running-in Check

The BMW running-in check has to be performed when the motorcycle has covered between 500 km and 1200 km

BMW Service

The BMW Service is carried out once a year; the extent of servicing can vary, depending on the age of the motorcycle and the distance it has covered. Your authorised BMW Motorrad dealer confirms that the service work has been carried out and enters

the date when the next service will be due.

Riders who cover long distances in a year might have to bring in their motorcycles for service before the next scheduled date. It is to allow for these cases that a maximum odometer reading is entered as well in the confirmation of service. Servicing has to be brought forward if this odometer reading is reached before the next scheduled date for the service.

The service-due indicator in the multifunction display reminds you about one month or 1000 km in advance when the time for a service is approaching, on the basis of the programmed values.

Confirmation of maintenance work

BMW Pre-delivery Check

Completed

on _____

Stamp, signature

BMW Running-in Check

Completed

on _____

Odometer reading _____

Next service
at the latest

on _____

or, if logged beforehand,

Odometer reading _____

Stamp, signature

BMW Service

Completed

on _____

Odometer reading _____

Next service
at the latest

on _____

or, if logged beforehand,

Odometer reading _____

Stamp, signature**BMW Service**

Completed

on _____

Odometer reading _____

Next service
at the latest

on _____

or, if logged beforehand,

Odometer reading _____

Stamp, signature**BMW Service**

Completed

on _____

Odometer reading _____

Next service
at the latest

on _____

or, if logged beforehand,

Odometer reading _____

Stamp, signature

BMW Service

Completed

on _____

Odometer reading _____

Next service
at the latest

on _____

or, if logged beforehand,

Odometer reading _____

Stamp, signature**BMW Service**

Completed

on _____

Odometer reading _____

Next service
at the latest

on _____

or, if logged beforehand,

Odometer reading _____

Stamp, signature**BMW Service**

Completed

on _____

Odometer reading _____

Next service
at the latest

on _____

or, if logged beforehand,

Odometer reading _____

Stamp, signature

BMW Service

Completed

on _____

Odometer reading _____

Next service
at the latest

on _____

or, if logged beforehand,

Odometer reading _____

Stamp, signature**BMW Service**

Completed

on _____

Odometer reading _____

Next service
at the latest

on _____

or, if logged beforehand,

Odometer reading _____

Stamp, signature**BMW Service**

Completed

on _____

Odometer reading _____

Next service
at the latest

on _____

or, if logged beforehand,

Odometer reading _____

Stamp, signature

BMW Service

Completed

on _____

Odometer reading _____

Next service
at the latest

on _____

or, if logged beforehand,

Odometer reading _____

Stamp, signature**BMW Service**

Completed

on _____

Odometer reading _____

Next service
at the latest

on _____

or, if logged beforehand,

Odometer reading _____

Stamp, signature**BMW Service**

Completed

on _____

Odometer reading _____

Next service
at the latest

on _____

or, if logged beforehand,

Odometer reading _____

Stamp, signature

Confirmation of service

The table is intended as a record of maintenance, warranty and repair work, the installation of optional accessories and, if appropriate, special campaign (recall) work.

Item	Odometer reading	Date

A

- Abbreviations and symbols, 6
- ABS
 - Control, 16
 - Engineering details, 74
 - Operation, 53
 - Self-diagnosis, 66
 - Warnings, 30
- Accessories
 - General instructions, 80
- Air filter
 - Installation, 115
 - Position on the motorcycle, 15
 - Removal, 114
- Anti-theft alarm
 - Telltale light, 18
 - Warnings, 38

B

- Battery
 - Charging, 117
 - Installation, 118
 - Maintenance instructions, 116
 - Removal, 118
 - Stowage, 15
 - Technical data, 135

- Brake fluid
 - Checking fluid levels, 96
 - Reservoir, front, 13
 - Reservoir, rear, 13
- Brake pads
 - Checking brake-pad thickness, 95
 - Running in, 67
- Brakes
 - Adjusting handlebar lever, 54
 - Checking operation, 94
 - Safety instructions, 68
 - Technical data, 132
- Bulbs
 - General instructions, 108
 - Overview, headlights, 19
 - Replacing high-beam headlight bulb, 109
 - Replacing low-beam headlight bulb, 108
 - Replacing number-plate light bulbs, 113
 - Replacing side-light bulb, 110
 - Replacing turn indicator bulbs, 111

- Technical data, 136
- Warning for bulb failure, 28

C

- Case
 - Operation, 83
- Chain
 - Adjusting tension, 100
 - Checking tension, 99
 - Checking wear, 100
 - Lubricating, 99
- Checklist, 64
- Clock, 22
 - Adjusting, 42
 - Control, 18
- Clutch
 - Adjusting handlebar lever, 54
 - Checking operation, 98
 - Technical data, 131
- Confirmation of maintenance work, 142
- Coolant
 - Checking fill level, 97
 - Fill-level indicator, 13
 - Filler neck, 13

Temperature gauge, 23, 24
Topping up, 98
Warning for
 overtemperature, 27
Currency, 7

D

Damping
 Adjuster, rear, 13
 Adjusting rear, 57
Dimensions, 137
Display
 See multifunction display, 18

E

Electrics
 Technical data, 135
Electronic immobiliser (EWS), 41
 Warning, 27
Emergency off switch (kill
 switch), 17
 Operation, 52

Engine

 Control, 17
 Starting, 64
 Technical data, 129
 Warning for engine
 electronics, 28
Engine oil
 Checking fill level, 93
 Dipstick, 11
 Filler neck, 11
 Technical data, 130
 Topping up, 94
 Warning for engine oil
 pressure, 28
Equipment, 7

F

First-aid kit
 Stowage, 14
Frame
 Technical data, 137

Front-wheel stand
 Installing, 106

Fuel

 Fill-level indicator, 23, 24
 Filler neck, 13

Refuelling, 71
 Technical data, 4, 130
 Warning for fuel down to
 reserve, 27

Fuses, 135

G

Gear indicator, 23
General views
 Headlight, 19
 Instrument cluster, 18
 Left handlebar fitting, 16
 Left side of motorcycle, 11
 Right handlebar fitting, 17
 Right side of motorcycle, 13
 Underneath the seat, 14
 Underneath the trim panel, 15
Grip heating
 Control, 17
 Operation, 53

H

Handlebar fittings
 General view, left side, 16
 General view, right side, 17

Hazard warning flashers
Control, 16, 17
Operation, 51

Headlight
Beam throw, 58
Driving on right/driving on left, 58
Overview, 19

Headlight flasher, 16

Helmet holder, 14, 60

High-beam headlight
Control, 16
Switching on, 49
Telltale light, 22

Horn, 16

I

Idle
Telltale light, 22

Ignition
Switching off, 40
Switching on, 40

Instrument cluster
Overview, 18

J
Jump starting, 115

K
Keys, 40, 42

L
Laying up, 124

Lights
Headlight flasher, 49
Switch on the high-beam headlight, 49
Switch on the parking lights, 50
Switching on the low-beam headlight, 49
Switching on the side lights, 49

Low-beam headlight
Switching on, 49

Luggage
Instructions for loading and securing objects, 81

M
Maintenance intervals, 141

Mirrors
Adjusting, 55

Motorcycle
Laying up, 124
Parking, 70
Restoring to use, 124

Multifunction display, 18
Status indicators, 22

O
Odometer and tripmeters, 22
Control, 18
Operation, 42

Off-roading, 68

On-board computer
Ambient temperature, 44
Average consumption, 45
Average speed, 44
Control, 16
Operation, 43
Range, 45
Redline warning, 48
Status indicators, 23
Stopwatch, 46
Warnings, 29

- P**
Parking, 70
Parking light
 Switching on, 50
Power socket, 11, 80
Pre-ride check, 65
- R**
Refuelling, 13, 71
Reserve volume
 Warning, 27
Restoring to use, 124
Rev. counter, 18
Rider's Manual
 Stowage, 14
Running gear
 Technical data, 132
Running in, 67
- S**
Safety instructions
 Brakes, 68
 General, 62
- Seat
 Installation, 59
 Lock, 11
 Removal, 59
Service Card, 140
Service-due indicator, 22
Side light
 Switching on, 49
Spark plugs
 Technical data, 135
Speedometer, 18
Spring preload
 Adjuster, rear, 13
 Adjusting rear, 56
 Tools, 14
Starting, 64
Status indicators
 See also warnings, 22
 Standard status indicators, 22
 With on-board computer, 23
 With RDC, 24
Steering lock, 41
Stopwatch
 Control, 18
- T**
Technical data
 Battery, 135
 Brakes, 132
 Bulbs, 136
 Clutch, 131
 Dimensions, 137
 Electrics, 135
 Engine, 129
 Engine oil, 130
 Frame, 137
 Fuel, 4, 130
 Running gear, 132
 Spark plugs, 135
 Standards, 7
 Transmission, 131
 Weights, 138
 Wheels and tyres, 133
Telltale lights, 22
Toolkit
 Contents, 92
 Stowage, 14
Topcase
 Operation, 86
Torques, 127

- Transmission
 - Technical data, 131
- Troubleshooting chart, 126
- Turn indicators
 - Control, left, 16
 - Control, right, 17
 - Operation, 50
 - Telltale light, 22
- Type plate, 13
- Tyre pressure monitoring RDC
 - Adhesive label for rim, 102
 - Engineering details, 76
 - Operation, 48
 - Status indicators, 24
 - Warnings, 32
- Tyres
 - Checking inflation pressure, 58
 - Checking tread depth, 98
 - Pressures, 4, 134
 - Recommendation, 101
 - Running in, 67
 - Table of tyre pressures, 14
 - Technical data, 133

V

- Vehicle identification number, 13

W

- Warning light for engine rpm, 18

- Warnings, 24

- Mode of presentation, 24

- With ABS, 30

- With anti-theft alarm, 38

- With on-board computer, 29

- With RDC, 32

- Warnings, overview, 26, 31, 34

- Weights, 138

- Payload table, 14

- Wheels

- Change of size, 101

- Checking rims, 99

- Installing front wheel, 103

- Installing rear wheel, 105

- Remove the front wheel, 102

- Removing rear wheel, 104

- Technical data, 133